

ELECTRATHON AMERICA

2021

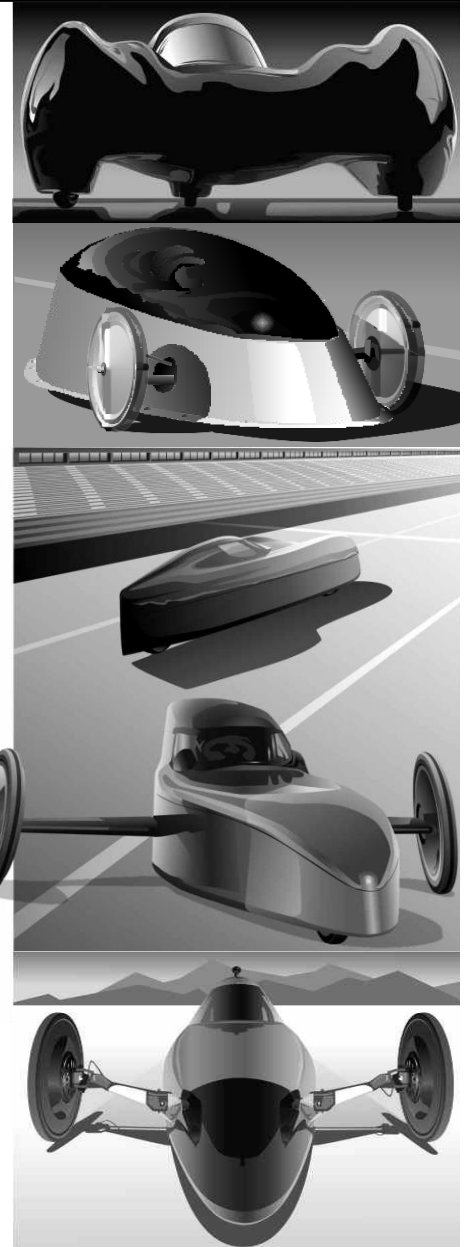
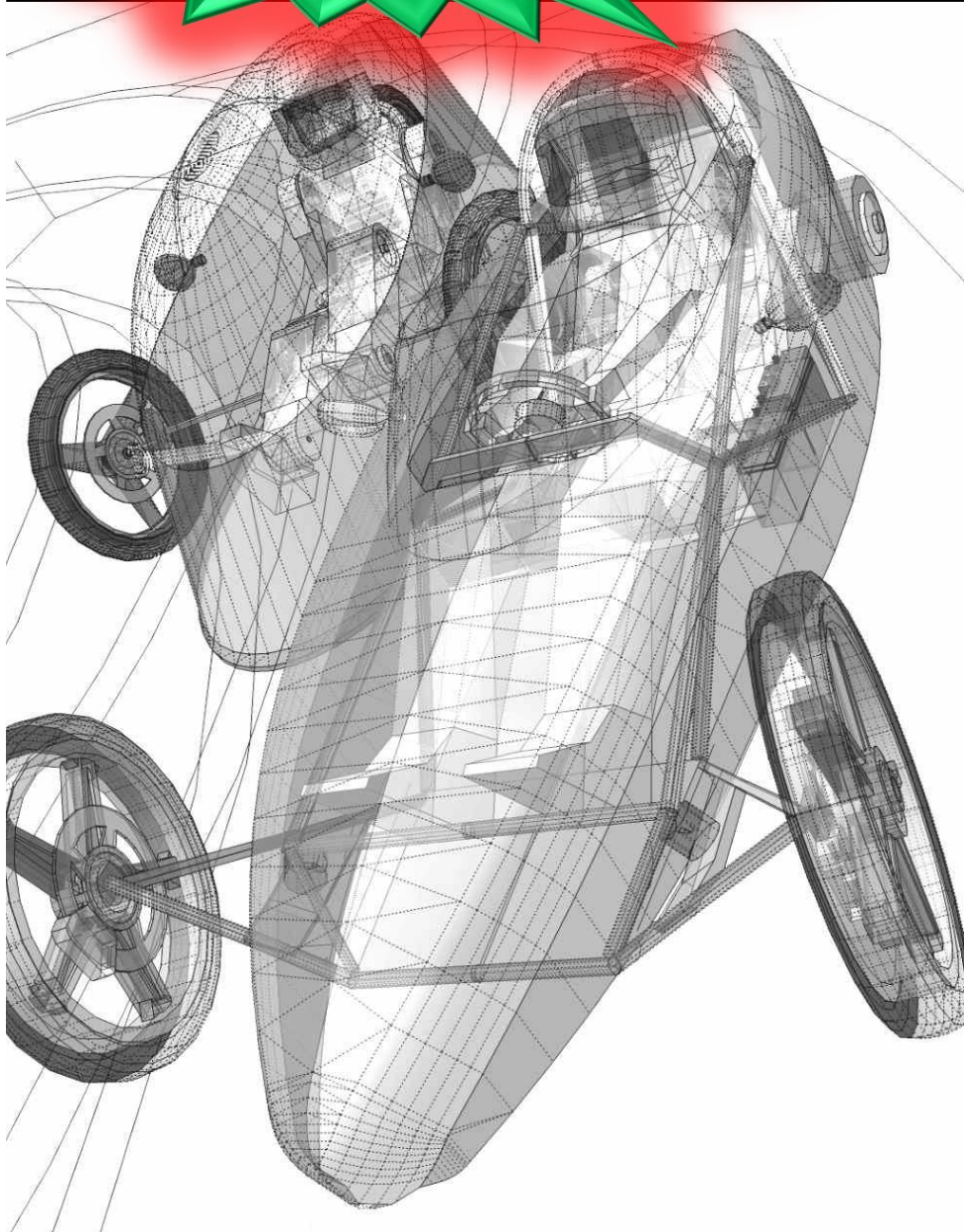

HANDBOOK

Revision K, effective April 8th 2021 unless superseded by newer revision at www.ElectrathonAmerica.org

electrathonamerica@gmail.com

ELECTRATHON AMERICA

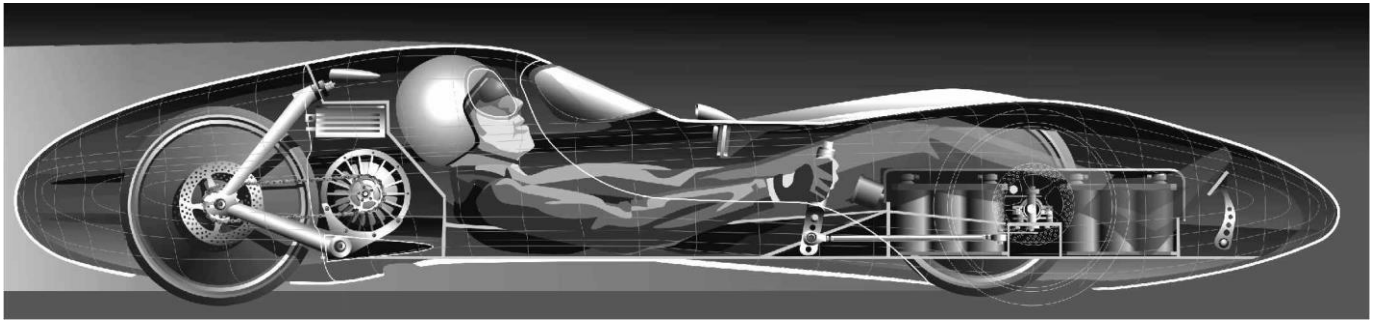

ORIGINAL HANDBOOK DESIGN & ILLUSTRATION BY C. MICHAEL LEWIS
 Subsequent revisions have been made as needed

| | |
|---------------|------|
| | page |
| OBJECTIVES. | 3 |
| MEMBERSHIP | 4 |
| RULE CHANGES. | 4 |

Vehicle Design

| | |
|----------------------------|--------|
| Rules | Page 5 |
| DIMENSIONS | 6 |
| CONFIGURATION | 6 |
| FRAME | 6 |
| ROLL BAR | 6 |
| VEHICLE BODY | 7 |
| STABILITY | 7 |
| LEANING VEHICLES | 7 |
| STEERING | 7 |
| BRAKES and AXLES | 8 |
| WHEELS and TIRES | 8 |
| BATTERIES | 8 |
| ELECTRICAL SYSTEM | 9 |
| ISOLATION SWITCH | 9 |
| MOTOR and TRANSMISSION | 10 |
| MOTOR CONTROLLER | 10 |
| NUMBERS | 10 |
| MIRRORS | 10 |
| SAFETY BELTS | 10 |
| HELMETS | 11 |
| DRIVING POSITION | 11 |
| DRIVER'S ATTIRE | 11 |
| CELL PHONE/COMMUNICATION | 11 |
| EXITING THE VEHICLE | 11 |
| DRIVER AGE & COMPETENCE | 11 |
| COMPETITOR MEMBERSHIP CARD | 12 |
| DRIVER'S WEIGHT/BALLAST | 12 |
| SOLAR CLASS | 12 |
| ADVANCED BATTERY CLASS | 12 |
| COMPLIANCE | 12 |

Vehicle Design Tips

| | |
|---------------------------|---------|
| | Page 13 |
| ATTITUDE | 14 |
| BUILDING YOUR ELECTRATHON | 15 |
| TESTING | 15 |
| CHASSIS DESIGN | 15 |
| STABILITY | 16 |
| BODIES | 16 |
| CANOPIES | 17 |
| STEERING SYSTEMS | 18 |
| STEERING GEOMETRY | 19 |
| SUSPENSION | 20 |
| DRIVE TRAIN | 21 |
| WHEELS | 22 |
| BRAKES | 23 |
| AXLES | 23 |
| MOTORS | 24 |
| MOTOR CONTROLLERS | 24 |
| INSTRUMENTS | 24 |
| BATTERIES | 25 |
| RESOURCES | 26 |

Event/Host Rules

| | |
|----------------------------|-----------|
| | Page 27 |
| SANCTIONED EVENTS | 28 |
| ELIGIBILITY | 28 |
| DEMONSTRATIONS | 28 |
| CLASSES AND DIVISIONS | 29 |
| COURSE REQUIREMENTS | 30 |
| TIMING AND SCORING | 31 |
| ENTRY FEES | 31 |
| PRIZE MONEY | 31 |
| VEHICLE INSPECTION | 32 |
| DRIVERS MEETING | 32 |
| COMPETITION FLAGS | 32 |
| STARTING GRID | 33 |
| VELODROME RULES | 33 |
| VIDEO CAMERA | 33 |
| COURSE COMMUNICATION | 33 |
| ROLES AND RESPONSIBILITIES | 34 |
| COMPETITION NUMBERS | 37 |
| RULES OF THE ROAD | 38 |
| EVENT INSURANCE | 39 |
| EVENT CHRONOLOGY | 40 |
| FORMS: | 43 |
| VEHICLE INSPECTION FORM | 44 |
| DRIVER INSPECTION FORM | 45, 46 |
| OFFICIAL PROTEST FORM | 47 |
| LAP TALLY SHEETS | 48, 49 |
| REVISION HISTORY | 50 |
| CALCULATIONS | 51 |
| RECORD SETTERS | 52 |

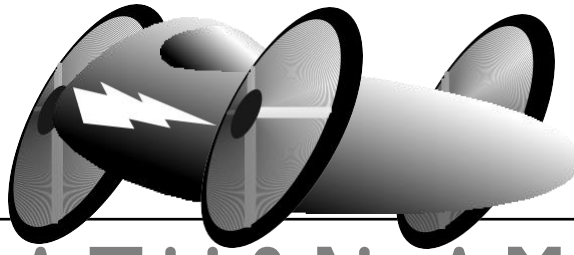

ELECTRATHON AMERICA

Our MISSION: *To inspire an interest in Science, Engineering, and Technology by involving participants in the design, construction, testing and development of competitive electric vehicles.*

COMPETITION OBJECTIVES:

1. To drive electrically powered vehicles as far as possible in one hour on a closed loop course with limited electrical energy.
2. To provide a forum where skill and ingenuity may be displayed, compared and tested.
3. To improve public awareness and understanding of efficient alternative electric vehicles and related technologies.
4. To create an affordable sport defined by established rules in which **Schools, Individuals** and **Corporate Teams** can participate competitively and safely.

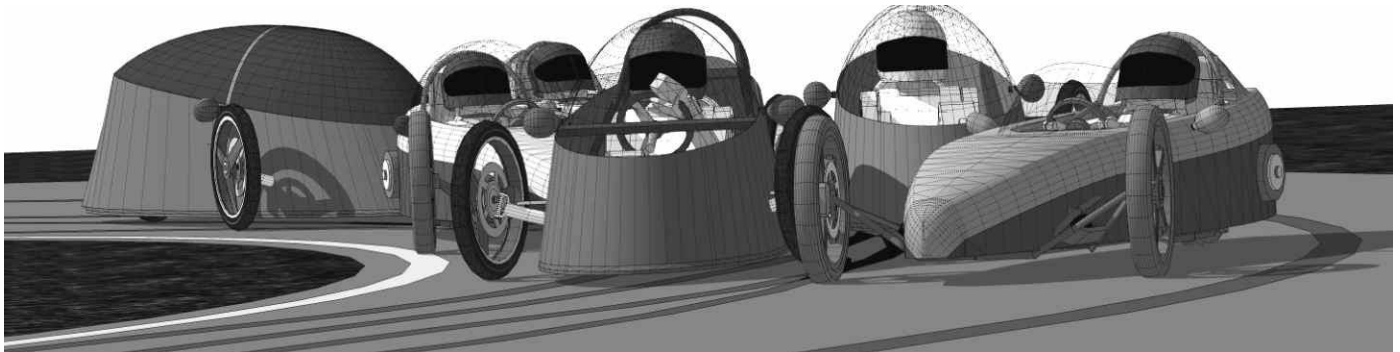

VEHICLES

Electrathon vehicles are single person, lightweight, aerodynamic, high efficiency, electric vehicles with three or four pneumatic tires. They must meet specific design and safety rules. They are powered by standard sealed (won't leak if damaged) lead acid battery packs not exceeding the weight limit specified in the vehicle design rules section.

SAFETY

Safety is of key concern at all events. The design of the vehicles is only one variable in the safety of an event. A pre-race inspection of the vehicles is required to ensure they are safe. Event courses must be free from obstructions, and ensure participants and spectators are not in harms way. These are just some of the sanctioning regulations.

For these safety reasons local Event Organizers, Promoters, and Event Stewards may not make ANY changes to the Electrathon America Design and Event Rules other than where specific guidelines for deviation are listed.

To be an Electrathon America Sanctioned Event, the Event Rules must be enforced during the event and all vehicles participating in the event must meet current Vehicle Design rules.

MEMBERSHIP

A Competitor Membership is required for those wishing to compete in sanctioned Electrathon America events. It includes number registration for one vehicle, one Handbook, and one vote on any suggested rule changes that are presented by the Electrathon America Board during the Event Season. The membership voting rights also include the vote to appoint Electrathon America Board Members. The membership application form is available at the back of this handbook.

All memberships are valid for the Event Season during which they are paid. The event season is from January 1st to December 31st. All rule changes approved by member vote will take effect January 1 of each event year. Rule changes will be published in the on-line Handbook as they are approved, at www.ElectrathonAmerica.org

Members are encouraged to communicate with the Electrathon America Director nearest to your location. The Board of Directors list is available at www.ElectrathonAmerica.org

Regional representatives are encouraged to participate as advisors to the Electrathon America board. Member surveys are used as needed to solicit opinion on rules and policy from the membership.

RULE QUESTIONS & CHANGES

Questions & Suggestions for rule changes of either the Design Rules or Event/Host Rules must be emailed to electrathonamerica@gmail.com with "Attention Directors" in the body of the message. If a proposal is consistent with the mission and objectives of Electrathon America competition and will improve the sport, the Board of Directors may present the proposal to the current year membership for an official vote.

However, Rules pertaining to the safety of participants and event spectators are decided by a vote of the Electrathon America Board of Directors. If passed, such rule changes will immediately be published to www.electrathonamerica.org in a revised version of the the on-line edition of the Handbook.

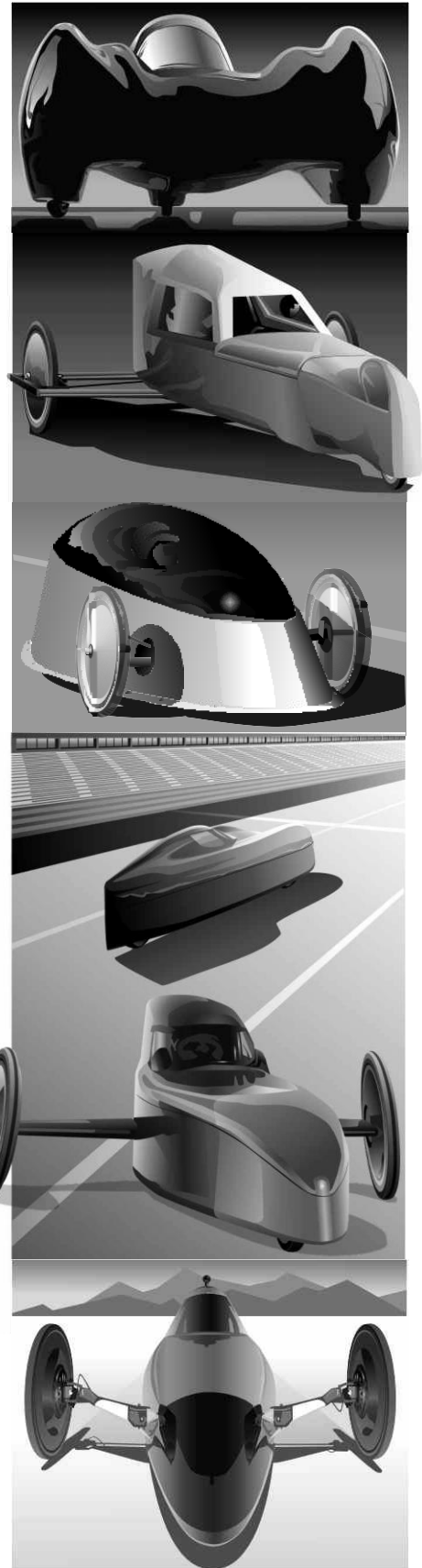

The Vehicle Design Rules are maintained by Electrathon America and enforced at sanctioned events. They are provided to promote safe and fair competition.

Since safety is of key concern these rules should be considered minimum requirements. These rules will be in force and these requirements must be maintained during the entire competition. Any vehicle should be able to pass inspection at any time during a competition.

Experimentation of design and ingenuity are encouraged, but keep in mind the intent of safe competition for the driver and the other participants of an event. If a new concept is being attempted that does not fit the rules exactly it may be wise to contact an event official or an Officer of Electrathon America before proceeding with construction. It would be unfortunate to complete a vehicle and then have it disqualified at a competition. Please remember that safety is a primary goal.

To better understand these rules and how they are enforced, please read the Event section that follows.

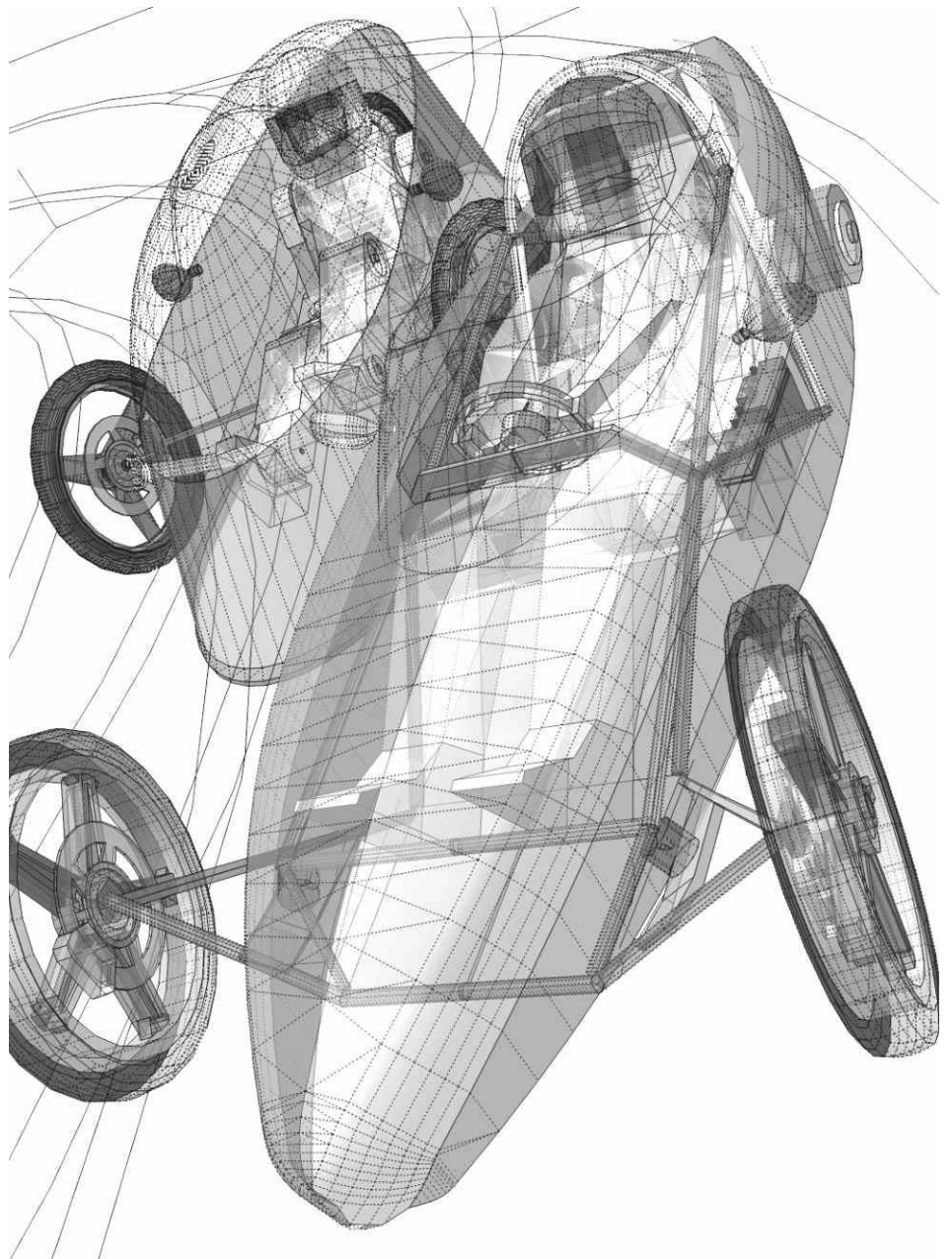

VEHICLE DESIGN RULES

1 DIMENSIONS

1. Minimum track (the distance the tires are apart) on at least one axle, is 2 feet center to center.
2. Maximum vehicle width is 4 feet at its widest point when the steering system is positioned as if driving in a straight line.
3. Maximum vehicle length is 12 feet.

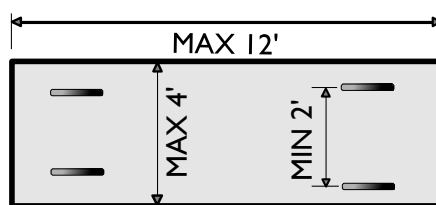

2 CONFIGURATION

1. All vehicles must be three-wheeled (cycle-car or tricycle) or four wheeled. Any configuration is allowed. All wheels must be load bearing, and remain in contact with the ground at all times, even under hard cornering conditions.

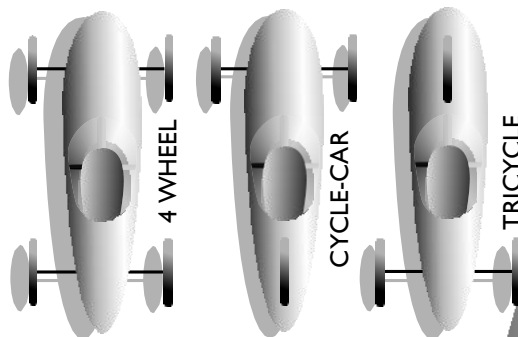

3 FRAME / FRAME MEMBERS

1. All vehicles must have frame members that protect the driver in the event of collisions from any direction.
2. Frames may be constructed of various materials and styles providing that the material(s) or methods provide adequate structural strength for protection/safety. The design will need to be structurally sound in the opinion of inspectors and/or race officials.

4 ROLL BAR

1. The roll bar must protect the driver's head/helmet in the event of a roll-over. It must be tall and wide enough to do this considering the full range of possible movement. (See drawing.)

2. The roll bar structure must be triangulated with at least three legs or panel equivalent. Triangulated bracing can be either forward or rearward. With three legs bracing must extend from the top of the roll bar and securely attach to the vehicle structure, with four legs, each of the braces must extend to within 4" of the top. Any roll bar that is constructed from more than one continuous piece must be reinforced and braced triangularly from all junctions/joints in addition to the top.

3. The roll bar structure must appear to be sturdy enough to withstand the vehicle being dropped, upside down, from an altitude of one foot, with the driver inside without failure.

4. The driver's helmet must be below a straight line drawn from the top of the roll bar to the top of the highest structural point when the driver is securely belted in driving position. (see drawing).

5. Composite or monocoque vehicles with integral rollover protection must meet comparable strength and clearance requirements.

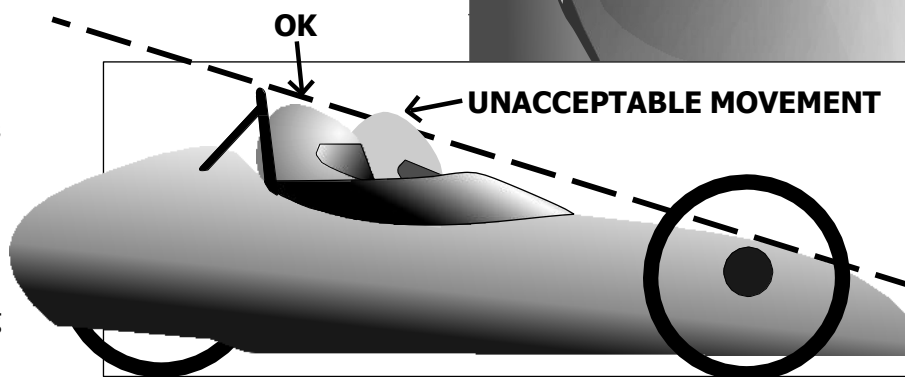
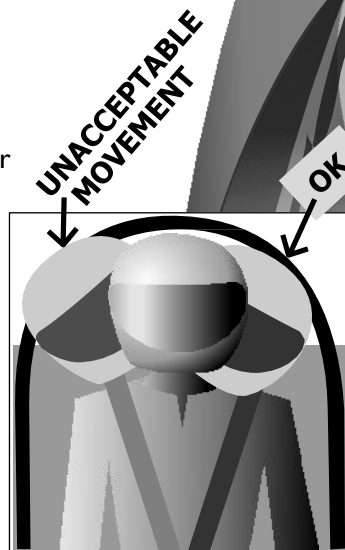



5 VEHICLE BODY

1. All vehicles must provide a body/chassis structure sufficient to protect the driver from impact from any side. A suitable structure or shell is required to provide a barrier between the driver and any contact with another vehicle or the ground.
2. This body or structure needs to protect the driver's legs, feet, and side up to shoulder level protecting the rib cage from side impact.
3. The legs and feet must be enclosed to prevent them from leaving the vehicle in an accident and provide protection against a frontal impact.
4. If the chassis contains a structural shell sufficient to protect the driver, then any body provided need not be structural. However, under no circumstances is the body to be made of cardboard, paper or any material that becomes weak when wet. Materials that are brittle or produce sharp edges when broken (e.g. Plexiglas or brittle acrylic panels) are also not allowed.
5. A body is not required if the frame or chassis shell will prevent the driver's arms and legs from leaving the vehicle and prevent another vehicle's parts from entering the vehicle during an accident.
6. The vehicle must not have any sharp edges, corners or protrusions that could cause injury. Any questionable exposed portion of the vehicle should be cut off, rounded off or blunted with durable padding.
7. The nose area must have a minimum radius of 3 inches (6-inch diameter) in at least one direction and not be dangerously pointed in the other direction.
8. The vehicle must have a fixed floor pan of solid-rigid material that prevents any part of the driver's body from contacting the ground.

6 STABILITY

1. All vehicles must demonstrate stability at rest, while cornering, braking and at top speed.
2. Driver contact with the ground cannot be used for stability.
3. Vehicles must be positively balanced and stable at all times while moving and at rest. Stability is critical for safety and must be maintained in off- camber turns, high-banked corners and in windy conditions.

7 LEANING VEHICLES

1. Leaning vehicles are permitted provided the driver is not required to balance the vehicle and stability requirements are met.
2. Leaning vehicles must use a mechanical device for actuation.
3. Vehicles which lean must have the ability to lock out the leaning capability of the vehicle for driver access and exit.

8 STEERING

1. Steering must permit a turning circle diameter of less than 50 feet curb to curb.
2. Any steering system must be well constructed and provide reliable steering action without looseness or binding.

9 BRAKES and AXLES

1. At least two wheels must have brakes.
2. Brakes must be fitted to two wheels of the same axle. Either both front wheels or both rear wheels depending on vehicle construction.
3. The two brakes must have separate actuation cables. If both brakes are to be actuated by a single hand or foot lever, then both cables should be attached to the lever.
4. Regenerative braking is permitted in addition to conventional brakes.
5. The vehicle must not roll if pushed while brakes are applied. The vehicle must also be able to demonstrate a straight stop from a speed of 25 MPH in less than 40 feet.
6. Axles supported at both ends must have a diameter of at least 3/8" (10mm).
7. Axles supported only on one end must have a diameter at least 1/2" (12mm).
8. Safety wire or cotter pins must be used to secure cantilevered wheel axle nuts. Nylon lock nuts and double nuts alone are not acceptable.

10 WHEELS and TIRES

1. Tires must be a pneumatic (inflatable) type.
2. Wheels and tires of any diameter or width may be used.
3. The minimum ground clearance is to be judged by the cars ability to roll over a 2x2 that is milled to be 1 1/2" x 1 1/2". This is to prevent the vehicle from sliding on the ground in the event of failure of any or all of the tires.
4. While in driving position the driver's body must not be able to come in contact with tires, wheels or spokes.

11 BATTERIES

1. Batteries must be lead acid only. Only batteries that will not leak if punctured, such as gel cell or AGM (Absorptive Glass Mat) will be allowed to participate at events in practice or in competition.
2. Battery number and voltage is not limited, but must meet specified weight limits, or must be the accepted battery types listed.
3. Batteries must display all original manufacturer's labels.
4. Batteries must be commercially retailed and available to any competitor. Custom built or specialized batteries are not allowed.
5. Batteries must be stock and unmodified in any way, and meet all conditions of the manufacturer's written warranty.
6. Total battery weight can not exceed 73 pounds. Total battery weight includes any batteries used for controls actuation, or functioning of the vehicle. Computers, radios or similar equipment are not included.
7. Batteries cannot be exchanged or recharged from an outside source during a competition. Batteries may be recharged by regenerative braking, or, in the Solar Class, through use of solar panels.
8. Batteries must be securely attached to the vehicle in such a manner to withstand an impact or roll-over.

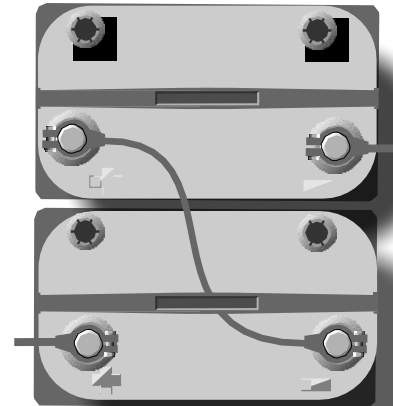
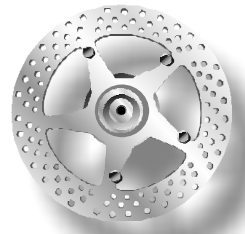

The following list of batteries are accepted as standard, meaning two of the following batteries will be allowed regardless of actual weight:

- Optima Yellow Top **D35, D75/25**
- Optima Red Top **SC25A, SC35A, SC75/35**
- Odyssey Genesis **G42 (VP, VPX, EP, EPX)**
- MK **40**
- Exide Orbital Model **75/35**
- Champion Vortex **75/35**

12 ELECTRICAL SYSTEM

Table adapted from National Electric Code (NEC) Handbook for standard automotive type cable, single conductor, not in a raceway or conduit.

| FUSE GUIDE | |
|---------------|----------------------|
| Wire size AWG | Fuse or Breaker Size |
| 20 | 5.5 AMPS |
| 18 | 9 AMPS |
| 16 | 12 AMPS |
| 14 | 15 AMPS |
| 12 | 20 AMPS |
| 10 | 30 AMPS |
| 8 | 80 AMPS |
| 6 | 105 AMPS |
| 4 | 140 AMPS |
| 2 | 200 AMPS |
| 1 | 250 AMPS |
| 1/0 | 300 AMPS |

For other cable types or configuration refer to an applicable NEC (National Electric Code) standard.

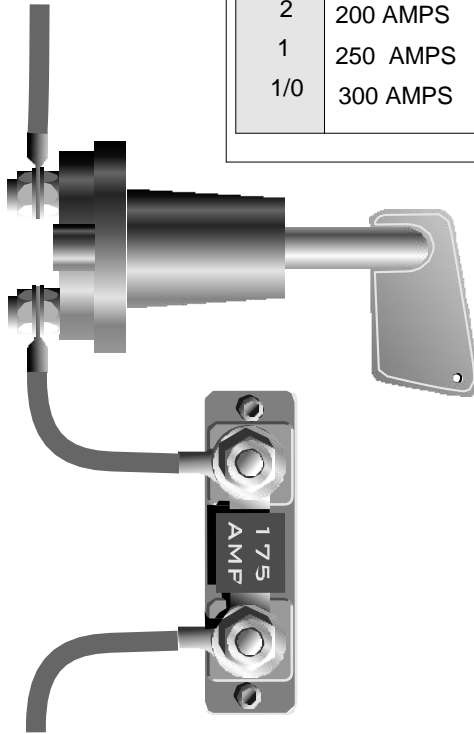

1. A fuse or circuit breaker is required in any electrical circuit between the battery and any electrical device.

2. All fuses or circuit breakers should be mounted as close as practically possible to the source of power.

3. All fuses or breakers should be sized to protect the wiring to which they are connected. The current rating of fuses and breakers shall be no more than those listed in the adjacent table for standard automotive cable.

13 ISOLATION SWITCH

1. An isolation switch (kill switch) is required on all vehicles. This switch must have a break current rating that exceeds the maximum current draw of the vehicle.

2. The switch must be located in the main positive power cable between the battery and any motor controller.

3. An actuator may be attached to the switch for remote operation provided that it is durable and reliable.

4. Means must be provided for both the driver and race officials to actuate an isolation switch.

5. The driver must be able to actuate the switch while in driving position and without reaching outside the vehicle.

6. Race officials must be able to actuate the switch from outside the vehicle without reaching in.

7. Two switches may be installed if necessary.

8. A circuit breaker may be used as the isolation switch.

9. The switch or actuator accessible from outside the vehicle must be mounted within a solid red triangle whose sides are at least 4 inches and in contrast to vehicle color or graphics.

10. Wiring must be well insulated and securely attached to the frame or body. All wiring must be kept free from moving parts and protected from chafing.

11. Wiring that passes through a hole with sharp edges or through sheet metal must be protected by an insulating grommet or other suitable device.

12. Terminals must be secured so they will not come loose or short out during a competition.

13. No part of the electrical system may use the vehicle frame as a conductor. The frame must not be grounded.

14 MOTOR and TRANSMISSION

1. Vehicles must only be powered by electric motors.
2. All gears, chains, and sprockets must be covered if they could cause injury to the driver or others in the event of mechanical failure.

15 MOTOR CONTROLLER

1. Any type of power (speed) controller is allowed.
2. Power to the motor must be controlled by the driver and turn off automatically when the driver releases the accelerator ("dead man" cut-off).
3. Remote control of a vehicle is not permitted.
4. Computers on or off the vehicle are legal systems if they present information only. The driver must have complete manual control of the vehicle and make all operational adjustments.

16 NUMBERS

1. All vehicles must display assigned vehicle competition numbers.
2. Vehicle numbers must be least 6 inches in height.
3. Numbers must be clearly visible on both sides of the vehicle.
4. The numbers must be in a contrasting color to the vehicle or number background. Out of state vehicles must also display their state abbreviation following the vehicle number in 3-inch-high letters.
5. Numbers or letters can be purchased when registering on membership form or by contacting the Treasurer of Electrathon America.

17 MIRRORS

1. Vehicles must be equipped with a minimum of 8 square inches of total usable mirror surface area. This may be one or two mirrors.
2. The mirror(s) must allow the driver to see clearly to the rear on both sides of the vehicle. This will be tested in a manner deemed appropriate by the inspector and race steward.
3. The driver must be able to see clearly to the front and both sides of the vehicle.
4. Electronic sensing devices, such as video cameras and monitors, may not be used as a substitute for rear view mirrors.

18 SAFETY BELTS

1. All vehicles must be equipped with a five-point automotive seat belt system.
2. All five belts must be securely attached to the vehicle frame structure by mechanical fasteners such as nuts, washers and bolts. Questionably small fasteners, zip ties and tape are unacceptable. The harness must be capable of lifting the entire vehicle from the ground with driver and batteries in place.
3. Each waist belts must be mounted to a structural point at least 3 inches below the top of the driver's waist.
4. The shoulder harness must be attached to a structural point at least 3 inches below the driver's shoulder without interference from the seat or other items.
5. The seat belt, shoulder harness and crotch strap must be able to hold the driver in a position that does not allow any excessive movement. The shoulder harness must be installed so that it can't slip off the driver's shoulders while driving. In the event of a sudden stop, it must prevent the driver from sliding forward and maintain the driver's shoulders in the "driving position". The seat belt must be able to hold the driver securely in place if the vehicle rolls over.

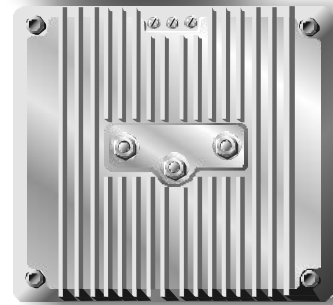
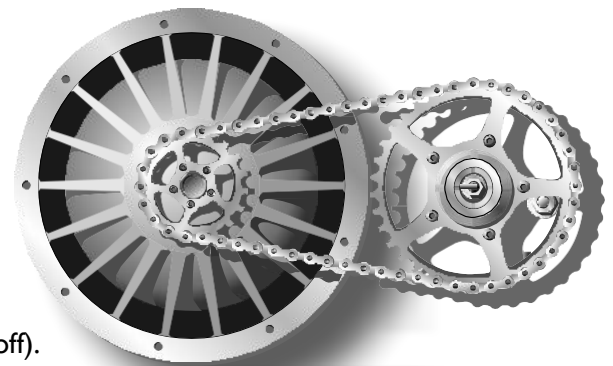

** With the available option for purchasing sanctioned numbers this rule will be strongly enforced with possibility of denial to race until standards are met to race host approval.*

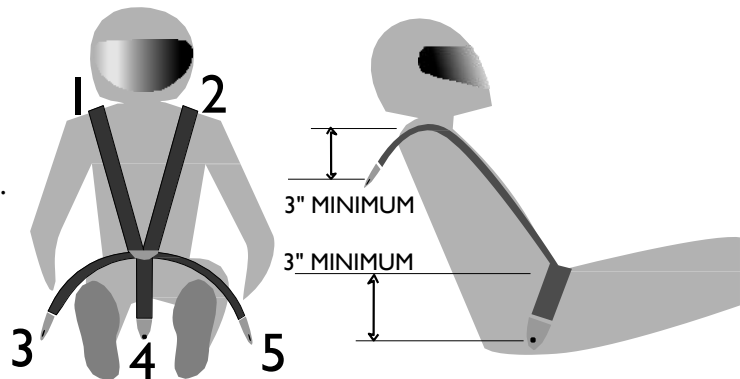

19 HELMETS

1. All drivers must wear a DOT approved full faced hard-shell helmet during competition. Bicycle and skateboard helmets are not acceptable.
2. Chin straps on helmets must be properly and securely fastened while operating an Electrathon Vehicle.

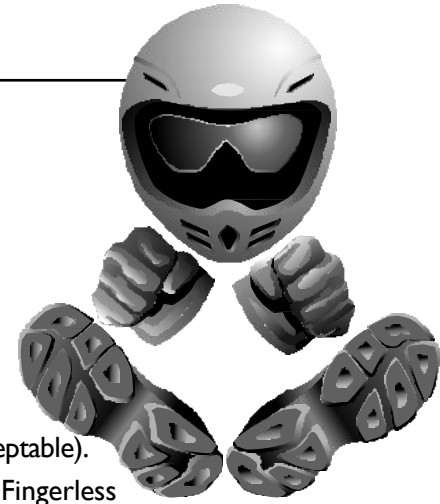

20 DRIVE ATTURE

1. Drivers must be fully clothed during competition.
2. Long sleeve shirts, pants and shoes are required (water socks and wrestling shoes are acceptable).
3. Gloves are required for open cockpit vehicles and optional for enclosed canopy vehicles. Fingerless gloves are allowed.
4. All drivers must wear eye protection while operating an Electrathon vehicle. Safety glasses with a Z87 rating, goggles, or a full face-shield helmet are acceptable.
5. Hair must be contained in such a way that all of it is unable to reach the drive train.
6. Necklaces, wrist and ankle bracelets, and large earrings must be removed.

21 CELL PHONE/COMMUNICATION DEVICES

1. Push to talk radios are permitted if the driver is not likely to be distracted by the action of Push To Talk.
2. Cell phones are permitted only when vehicle is at a stop (such as a breakdown) or when in hands free mode on an open line (no dialing).
3. Texting is banned whenever the driver is physically in the car.
4. Penalty for violation of the rules 21.2 or 21.3 is the offending car and driver's immediate removal (disqualification). After 2 violations in same calendar year the driver will be banned from using any electronic form of communication for the rest of the year.

22 DRIVING POSITION

1. Drivers must be in a sitting or recumbent (reclining) position. A kneeling, or prone (head-first) position is not permitted.
2. Arms and legs must remain within the vehicle body structure during competition.

23 EXITING THE VEHICLE

1. Drivers must be able to exit their vehicle as it is driven in competition, unaided in 20 seconds. This includes any external method of securing canopies.
2. Handicapped participants will be allowed up to 2 minutes aided exit.

24 DRIVER AGE & COMPETENCE

1. Event stewards are encouraged to disqualify any driver from competing if believed to be unsafe. Otherwise, drivers over 16 years of age who present a valid driver's license and proof of current Electrathon America registration may compete without prior testing or approval. Drivers over 14 years of age who present proof of current Electrathon America registration may compete if:
 - a) the event steward hasn't limited the event minimum age to 16 years. *Steward must ensure event advertising specifies.*
 - b) driver has obtained written approval (from event steward) to submit at event registration. This mandatory approval serves as proof that the steward (or a delegate of) tested the driver to demonstrate her/his ability to perform on the same or similar track conditions for at least 10 minutes. Requirements may be increased at the discretion of the event steward. It is the responsibility of the driver to contact the steward in advance of the event to plan testing. Approval may not be decided by a steward or delegate who is affiliated by team or familial ties to the driver.

25 COMPETITOR MEMBERSHIP CARD

1. To compete in a sanctioned event, all vehicles must be accompanied by an Electrathon America Competitor Membership Card. This card will be made available by Electrathon America and can be presented as proof of current year paid membership. The Event Organizer may request a computer roster of current competitor members to verify memberships.

26 BALLAST

1. Drivers must weigh a minimum of 180 pounds. This includes race clothing and helmet. Drivers under this weight limit must provide non-liquid ballast to increase their weight to the legal limit.
2. Ballast cannot be performance related items such as communication equipment or computers. However, non-performance items such as cameras or music systems may be permitted as ballast, provided they do not present a safety risk to the driver or other competitors.
3. Ballast must be removable for weigh in. Ballast must be securely attached to the vehicle in such a manner to withstand an impact or roll-over. If a vehicle loses its ballast during competition, it will be black flagged and disqualified.
4. Each driver is responsible for providing the correct amount of ballast.

27 SOLAR CLASS

All other Standard Class rules apply with the following additions:

1. Solar panels are permitted provided they are an integral part of the vehicle body and do not protrude to the front, sides or rear.
2. Wings or trailers are not permitted.

The Solar Class allows the use of photovoltaic cells to provide additional power during a race. In most cases that additional power will be more than offset by the increased weight and aero drag of the cells, and while the cost of PV cells is usually prohibitively expensive, they are often donated to schools. It was also felt that solar power offers a sustainable alternative to conventional energy sources, and fit the general objectives of Electrathon.

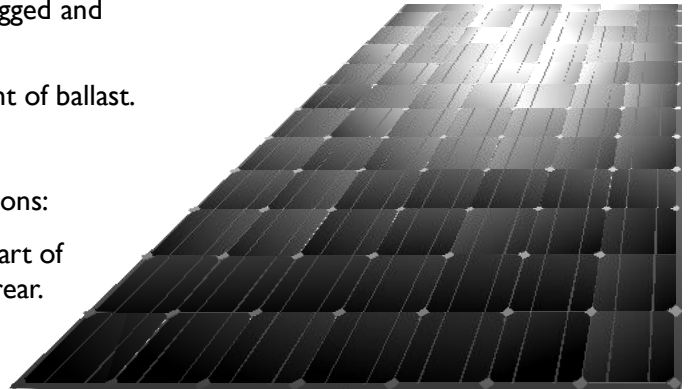

28 ADVANCED BATTERY CLASS

*The Advanced Battery Class is intended to foster experimentation on with newer battery technologies that offer higher energy density than the more traditional lead-acid and reflect the rapidly expanding availability and usage in the transportation industry. The weight limits are meant to keep the available power under **one kW-h**, or about the same as the current Standard Class. This list will be reviewed and updated periodically.*

All other Standard Class rules apply with the following exceptions:

1. Any type of the following sealed production batteries may be used as long as their weight does not exceed:

- Nickel-Metal-Hydride **41 lb.**
- Silver-Zinc **23 lb.**
- Nickel-Zinc **44 lb.**
- Nickel-Iron **58 lb.**
- Lithium-Ion **15 lb.**
- Lithium-Iron-Phosphate **29lb.**



2. Maximum output of any battery combination used may not exceed a one-hour rating of one kilowatt/hour according to the manufacturer's data.

29 COMPLIANCE

1. All vehicles must meet all Vehicle Design Rules to drive at any Electrathon America sanctioned event. This is true for competition, practice or testing and includes driver's clothing, safety equipment, batteries, battery securing systems, seat belts, etc.

ELECTRATHON AMERICA



VEHICLE DESIGN TIPS

VEHICLE DESIGN TIPS

It is not the intent for this section to tell you how to design and build a car, Electrathons vary widely in style and design. One of the most exciting parts of Electrathon is that the car you design is unique to you and your team! You are the engineers, the builders, the mechanics... It is the intent to guide you in a direction. Some experienced builders could easily write this section, while others look at the whole concept and just go blank, most builders are someplace in between.

ATTITUDE

Electrathon is fun. You are not going to get rich and famous doing this, but you will have fun. And you will learn something about how things work and about yourself. By establishing and refining simple rules, Electrathon is an elegant balance of design and strategy. No single factor is predominant, and the result is an international racing class known for its creative, competitive and efficient vehicles. Building a vehicle is an attainable challenge, and through friendly competition you gain insight and experience that will improve your chances of winning.



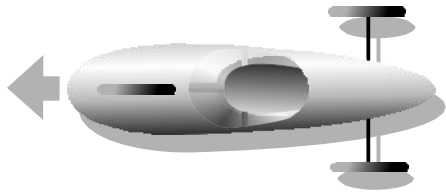

The **tricycle** offers a single wheel steering like a bicycle, and the opportunity to try front wheel drive or rear wheel drive.

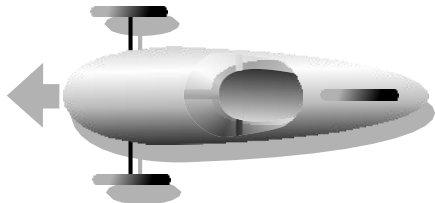

The **cycle car** steers with both front wheels, but requires a complex steering system. It offers a simple power train driving the rear wheel.

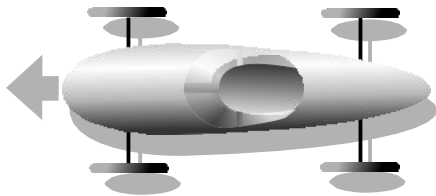

The **auto car** layout shares the weight among four wheels, and is less sensitive to placement of weight within the vehicle; but it has the added weight, complexity and rolling resistance of the extra wheel.

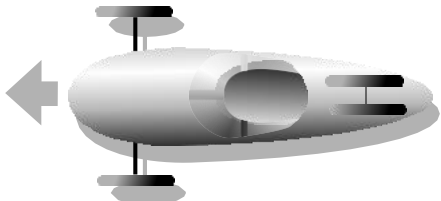

A **hybrid** variation. The increase in stability would come with the cost of additional drag, but it might be worth a try.

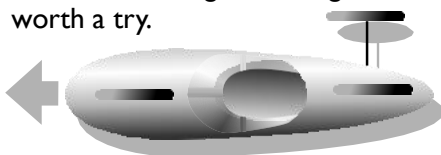

Side car? Here's an interesting variation that might have some advantages, but achieving the proper balance and stability might be difficult. Not for the beginner!

BUILDING YOUR ELECTRATHON

An Electrathon vehicle is much like a full size RC model car, except that you can get in and drive it. Since you are the driver, it is important to make it stable and safe for your protection, as well as the safety of the other drivers and spectators at the track. Building a competitive and safe vehicle is the challenge. The Electrathon rules have evolved over many years to help builders construct a well-designed and safe vehicle. An Electrathon competition combines speed, aerodynamics, handling and lightweight design to create a balanced performance formula. These guidelines offer suggestions to assist you in achieving that goal.

TESTING

This is where races are won or lost. Reliability is the single biggest factor in winning. You don't know what will break until you've tried to break it.

Testing on the bench will give you "benchmarks" and help you choose components. Simple coast down tests can be used to compare and evaluate tires and aerodynamic changes. Testing on a track will allow you to understand how various components work together. It will give you a chance to refine your chassis handling qualities and find your ideal gear ratios. With testing will come the winning edge.



CHASSIS DESIGN

The chassis is the backbone of your vehicle. Unless you are a veteran builder, you should try to keep your first chassis as simple and straight-forward as possible. While weight is a prevalent concern, it is actually only one of several factors that contribute to a successful Electrathon. Reliability is the key to winning. Most Electrathon courses are level, and acceleration is only a small part of the race. Although you will not want to build an overly heavy vehicle, concentrate on building a safe vehicle. Most Electrathons weigh over 350 pounds with driver, ballast and battery, so 10 to 20 extra pounds will be minor. It is more important that the design be strong.



Electrathon vehicles can be configured in a variety of layouts. Each design has disadvantages that you want to minimize, and advantages you want to optimize.

MONOCOQUES

(frameless, or unibody vehicles)

Experiments with a one-piece body/chassis could result in lighter vehicle designs. Like boats and aircraft, they can be very strong. This is an advanced technique using composites (fiberglass, Kevlar or carbon fibers with epoxy or polyester resins). Materials can be expensive, but the drawback is usually the cost and time to engineer a shell properly. Simple but effective designs have been built from wood and fiberglass using small boat construction methods. Some community colleges offer courses in composites.



STABILITY

A well-designed vehicle should be stable under all conditions and situations that might be encountered in a race. Competition places very high loads on a vehicle during tight cornering, even at relatively low speeds. It is therefore very important that the center of gravity of your vehicle be located below the axles. You need only a couple of inches of ground clearance on most race courses. Two to three inches is usually adequate, but make sure that you have clearance even if one, or all, of the tires are flat (this is a rule requirement).

Position the driver, batteries and motor so that the weight is carried low (to prevent flipping over), and near the center of the car (to reduce the tendency to spin). Each wheel should be equally weighted for best handling and control, but a bias toward the front will increase stability. This is easily measured (with driver and batteries on board) with bathroom scales, and can be adjusted by proper placement of the driver's ballast.

Lift an outboard wheel with driver on board. Your vehicle should not tip over at 33 degrees. (This is not necessarily the minimum angle, even steeper banked courses exist) A vehicle that doesn't tip at 33 degrees when static may do so under dynamic conditions typical during racing. Parking lots have potholes, streets have curbs, and when the pavement ends at a racetrack there is usually a little drop-off. All of these can flip a fast moving vehicle.

BODIES

AERODYNAMICS

Aerodynamic drag increases rapidly the faster you go, enough to be a deciding factor over the duration of the race. Wind resistance has a noticeable effect above 15 mph, and grows exponentially as the speed increases. Aerodynamic drag is the result of speed, frontal area and length of the vehicle and the shape of the body shell. At Electrathon speeds rounded fish-like teardrop shapes are very functional. Avoid abrupt bends, and flat surfaces. Make sure you can get in and out, and see well from inside the vehicle. Be sure you can get to the chain, tire and other adjustable components. Secure the body panels to the vehicle well, loose panels can create a lot of wind drag.



Creating a body shell is a challenge much like building a fiberglass boat or large model airplane. Work in the materials you know and ask around for advice on materials and techniques from plastic suppliers and fiberglass supply shops. Bodies have been made of fiberglass, fabric, steel and aluminum and plastic sheets, even light plywood. A shell is very functional in protecting you from other vehicles and the ground and, is one of the attractive features that make Electrathon distinctive. It can also help attract sponsors for your vehicle.

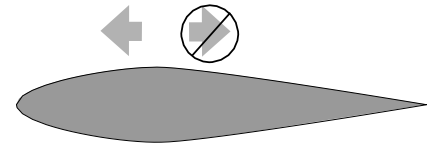

Up in free air the ideal shape to strive for, looking from the side or from the top, is an airfoil, or teardrop. Note that forward and backward are not the same.

Close to the ground the ideal shape looks like this in side view,

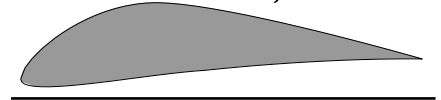

but if it is very close to the ground, this shape works nearly as well.



There is a practical limit to ground clearance, though, so it may be better to lift the body high enough to let the air escape.

WIND POWER

It may be possible to capture extra energy from the wind. In fact, we may already be sailing. Engineers have calculated that the net effect of a light wind from any direction will add noticeably to the speed of an aerodynamic vehicle traveling in a circle (or oval). The head wind is cancelled out by the tail wind, and the rest of the time you are on what sailors call a 'reach'.

While EA has approved the design concept, it has yet to be proven effective in practice.



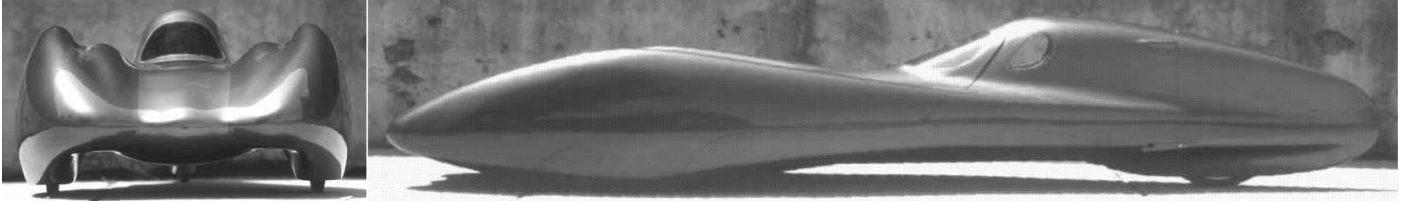

Frontal area, the size of the hole made in the wind, should be reduced as much as possible. Swept, or Wetted Area, the total amount of body in contact with the wind, should also be minimized. An open wheeled car may have less frontal area than a fully enclosed body, but that advantage could be offset by the increase in swept area.

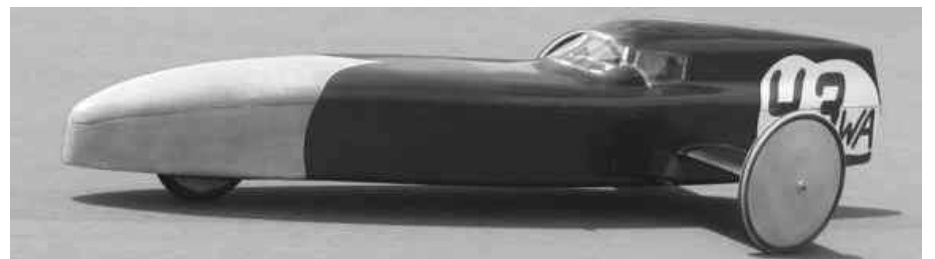
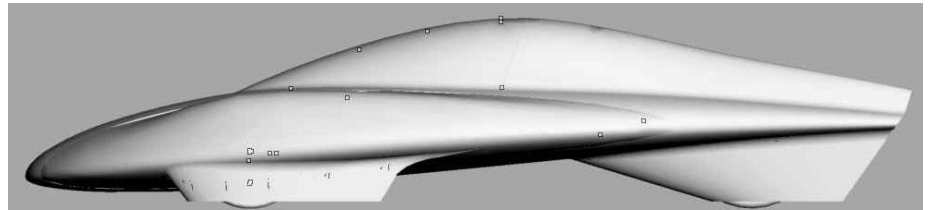
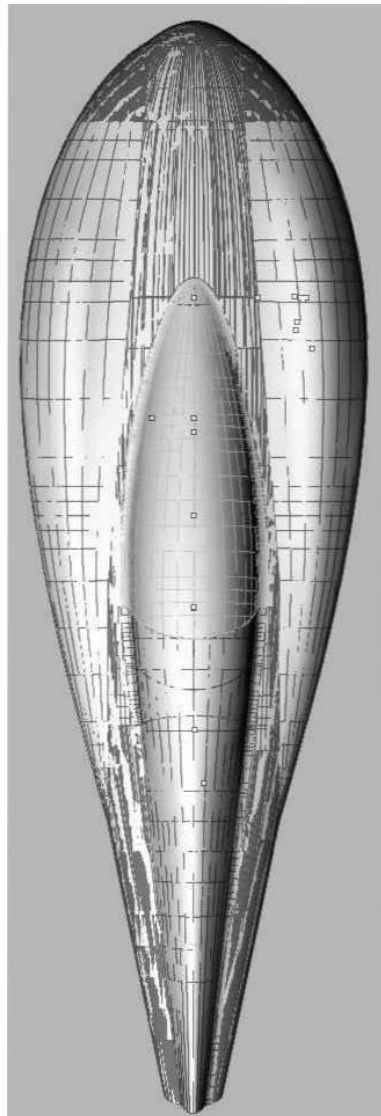
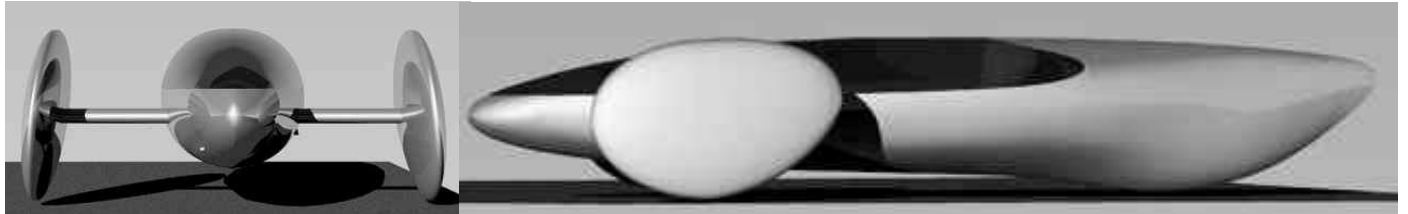

CANOPIES

A windshield is an important part of your body shell. Depending on your design, you can use clear plastic creatively bent to fit (sheets of acrylic and polycarbonate are readily available in various thicknesses), motorcycle fairings, or buy canopies from a variety of suppliers. Most commercial canopies are molded from these same materials, but this is a difficult process. Acrylic is cheaper, but more brittle and will shatter. It molds at a lower heat, but it doesn't bend as well as polycarbonate, which is also more scratch resistant.



STEERING SYSTEMS

There are a lot of steering systems out there, going into the choices and their variations would be a book in itself. Some vehicles use a steering wheel, some have a joy-stick like a plane, some use a tiller like a boat, and many use some sort of bicycle handlebar. Take a look at other Electrathon vehicles, go-karts, ATV's, and full sized cars. Talk to automotive technicians. Spend time on this aspect, and devise a good reliable system.

If you decide to build a cycle car your design will get a little more complex because you are steering two wheels. Tricycles, with a single steered wheel, can be simpler, unless you opt for front wheel drive, which can make the system even more complicated. Either way you need to design a proper geometry to be stable, maneuverable, and minimize tire wear.

There is no 'best', system, only what works best for the comfort and control of the driver. Determining the length and position of all the elements is probably best determined by trial and error, so build in as many extra mounting holes as you can. Good steering geometry is very important for control at any speed. On tight, short courses you generally want a quick and light response, but on longer, fast courses you want a heavier, more stable feel.

Don't even think about rear wheel steering. It works for fork lifts, but there are good good reasons you don't see it on anything faster than that. It's been tried, and usually ends in disaster.

TRICYCLE

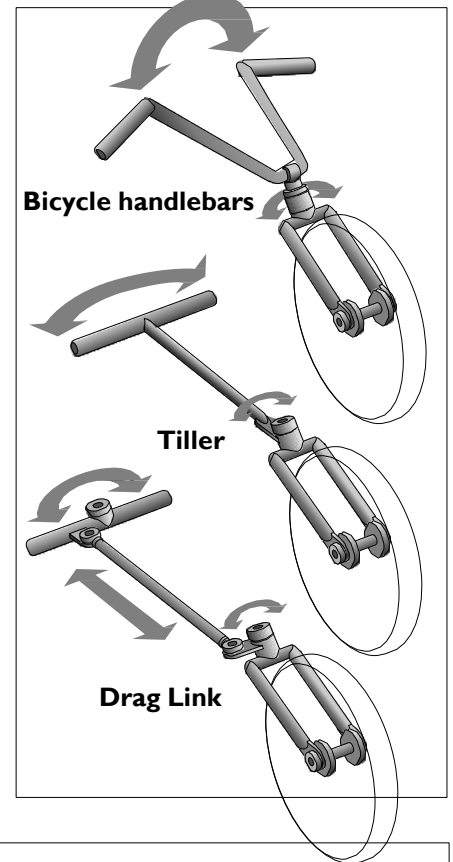

CYCLECAR

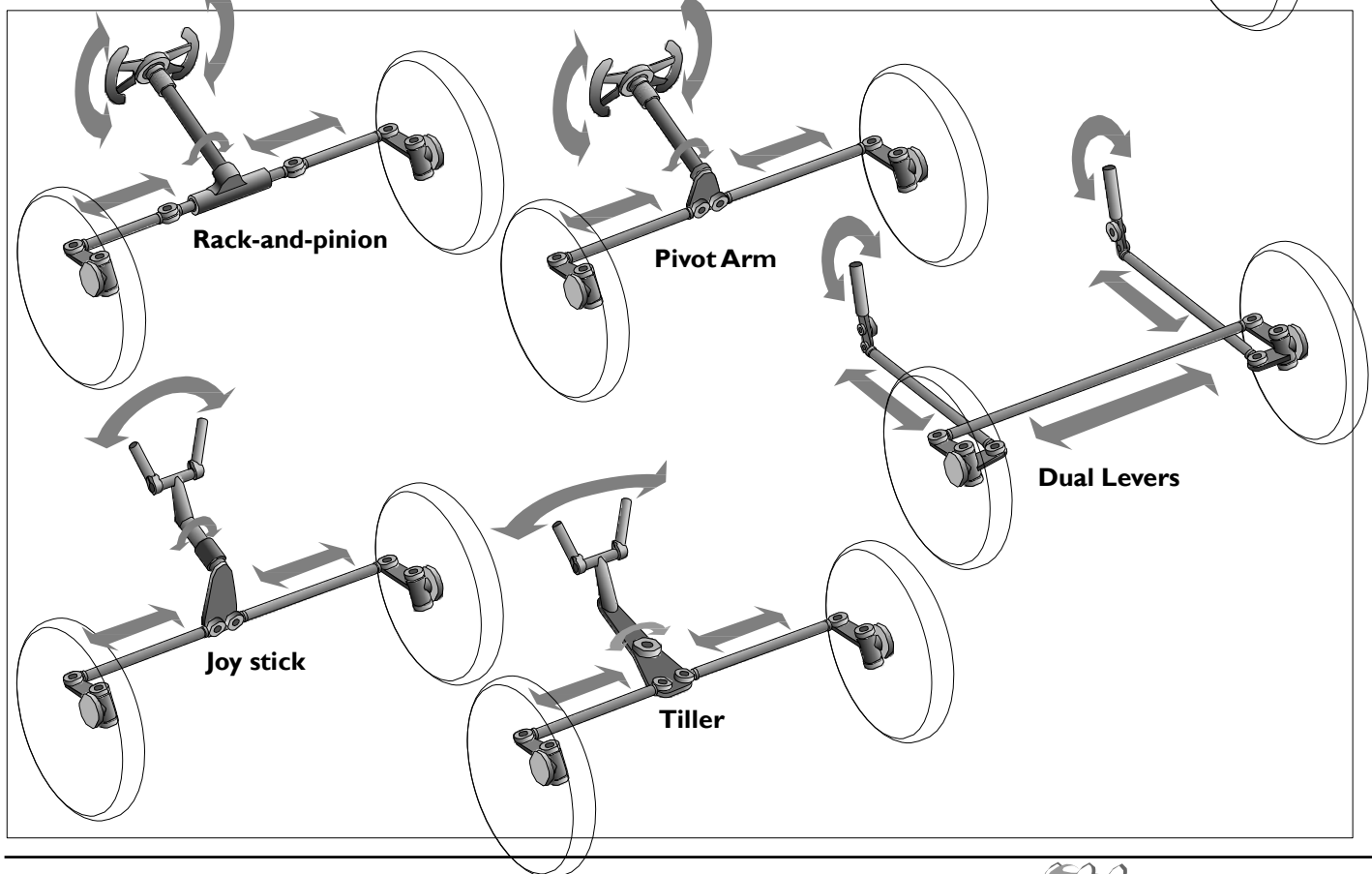

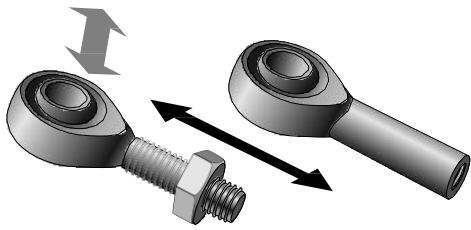

SPHERICAL ROD END BEARINGS

Also called Heim Joints, these are a very common and convenient way to link together all sorts of steering and suspension parts because they swivel and the threads allow you to adjust the length of your part. They come in various sizes, male and female, left or right hand threads. Using a left and right hand thread at either end of a rod means you can turn it to adjust the length without removing it.

They are meant to be used as links, so they are very strong in the horizontal, push/pull direction. They are not really built to take a lot of force in the vertical direction, but are often used as 'ball joints' anchoring a kingpin, which means they are supporting the weight of a bouncing car. If you use them this way, buy the biggest size and hardest grade you can afford, and check them often...they will get mashed with heavy use!

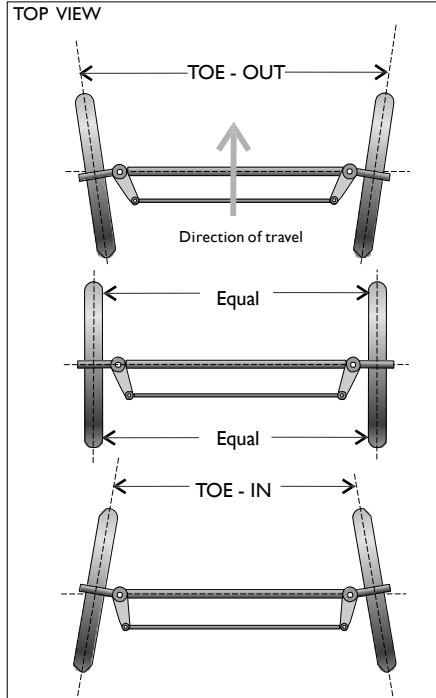

Although some race cars may handle better with a little toe-in or out, keeping it as neutral as possible will minimize rolling resistance.

When measuring the toe-in,, always measure the front and back of the tire at the same distance above the ground because the wheels may be cambered.

STEERING GEOMETRY

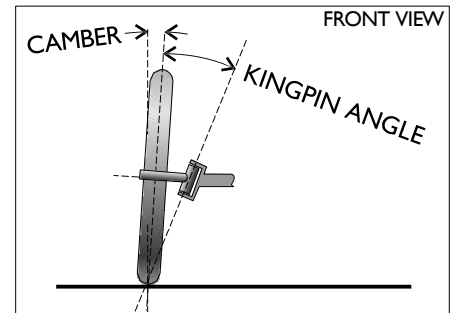

The centerline of the kingpin should intersect the point where the tire contacts the road to minimize tire scrub and insure proper steering action.

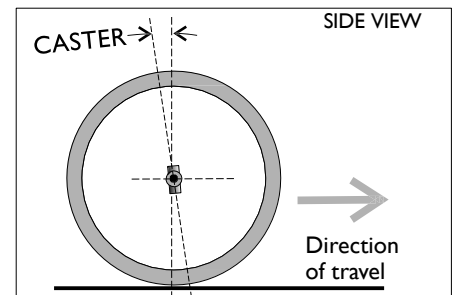

Increasing the caster, or rake angle, will increase straight line stability. Reducing it will improve maneuverability.

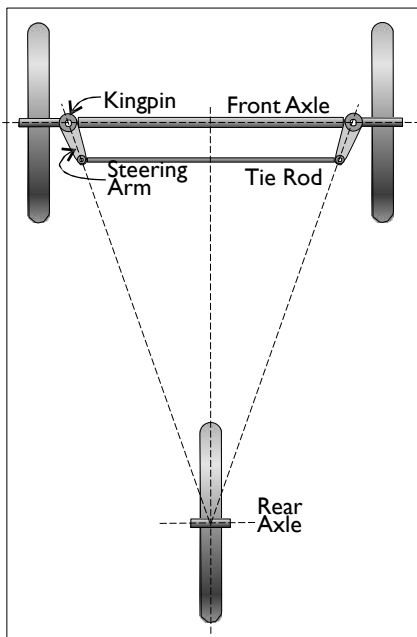

ACKERMANN ANGLE

The tie rod pivot should be on the line between the kingpin and the center of the rear wheel. This will allow each front wheel to follow a slightly different radius arc through a turn, greatly reducing rolling resistance and tire wear.

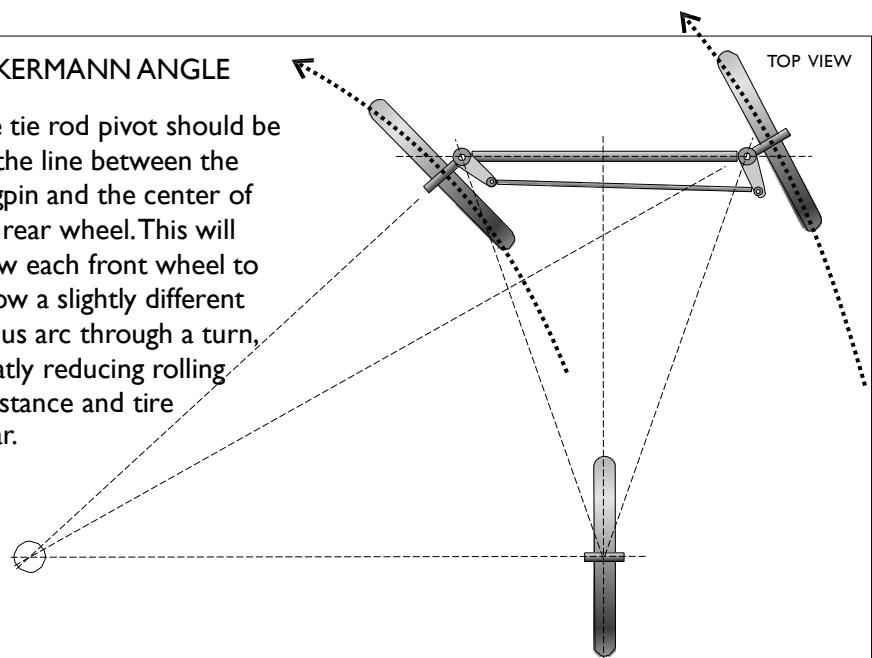

SUSPENSION

If you enjoy devising the linkages of a steering system, you will love getting into suspension. You don't need suspension in Electrathon, but it makes the ride better. Suspension is an advanced project. One of the unique characteristics of three wheeled vehicles is that the wheels will always be on the ground, no matter how uneven the ground may be. A three wheeled vehicle undergoes no twisting or torque in its chassis due to uneven terrain. A four-wheeled vehicle, on the other hand, needs a suspension in order to keep all its wheels on the ground and reduce stress on the chassis. Remember though, simplicity = reliability! You don't need much suspension travel, on a smooth track, the thickness of your tires may be all you need. Even a simple system can reduce vibration and jarring. Just suspending the seat will help.

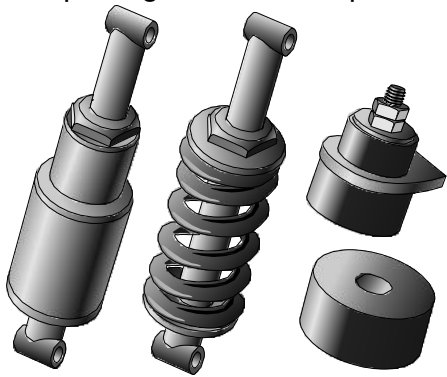

Springs carry the weight, shocks, or dampers, control the natural tendency of a spring-and-mass system to bounce. Often they are built together. Mountain bikes and ATV's are a good source because they are about the same weight as an Electrathon. You could just drill a bolt hole through a chunk of solid rubber...it doesn't even have to be round! Adding another chunk on the other side of your mount will increase its effectiveness by allowing for rebound.

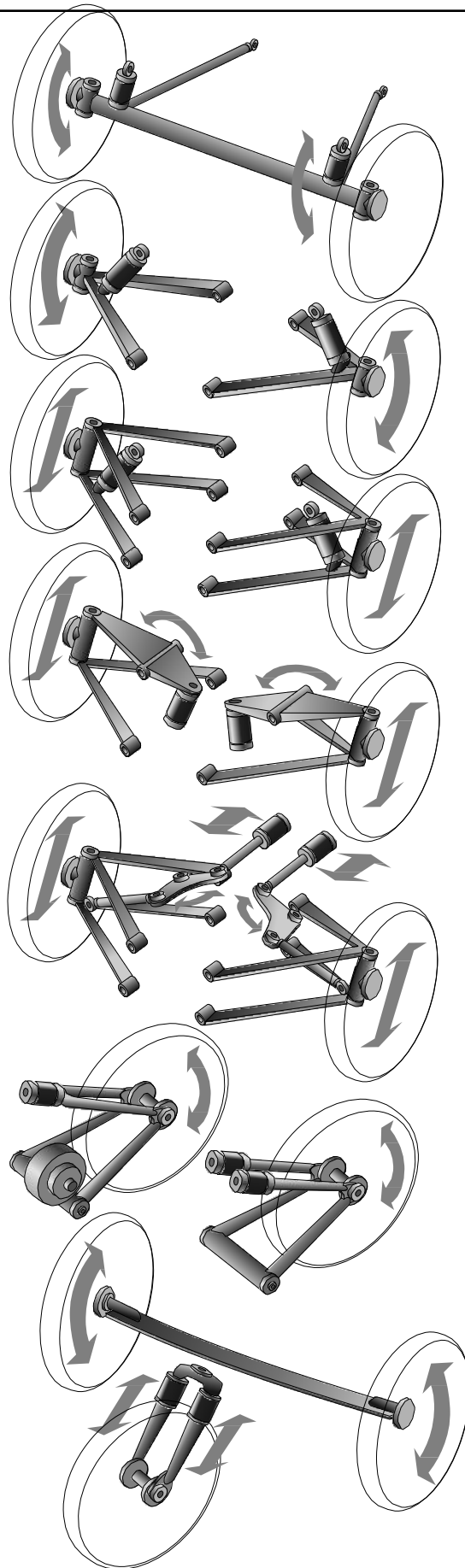

Solid Axle

Probably the simplest, but another link may need to be added if side loads are severe.

Swing Arm

Pretty simple, and works well with a rubber block. Having a lot of travel will create a lot of camber, so keep it short.

Upper and Lower A-Arm

The conventional set-up in real race cars, it keeps the tire perpendicular to the ground... very important for wide tires, but not an issue for thin, round profile tires. It involves a pretty complex geometry and a lot of time to build it right.

Rocker Arm

This set-up enables the spring and shock to be placed inside the car and out of the airflow, and works well with compact rubber blocks.

Rocker Arm/Pushrod

This is the modern Formula 1 arrangement, and allows room for a full coil/shock.

Rear Suspension

With many variations, this is the most common set-up for cyclecars. Using two dampers looks cool, but it allows the wheel to flex more under heavy side loads. Positioning the motor just forward of the hinge point will balance it with the weight of the wheel.

Tricycles

The front is the same as a bike or motorcycle, so either of those systems could be adapted. A solid axle with links would work on the back, or you could try a downhill ski.

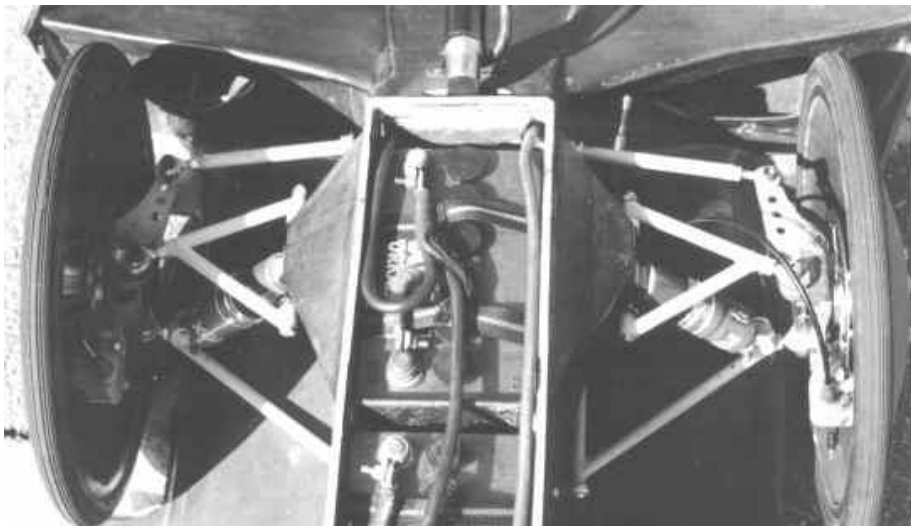

DRIVE TRAIN

Most vehicles use a direct drive chain (usually bicycle) or belt drive adapted to fit a bicycle threaded rear wheel hub. Unless you are using regenerative braking, you will want the drive to freewheel when you let off the power. Alignment and tension are critical. Too loose and it will pop off if the drive wheel flexes in turns and bumps; too tight and the friction will cost up to 5% power loss. Gear ratios are critical in tuning your performance and range, well worth the time spent experimenting. Each motor, battery voltage, wheel diameter and course type affects the gearing. A selection of sprockets or pulleys is a necessity. Some vehicles use multiple gear systems, although the added friction may cancel out that advantage.

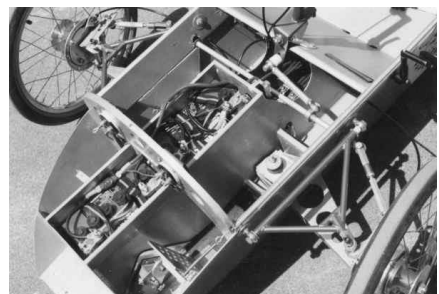
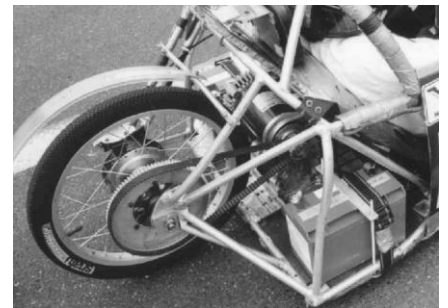
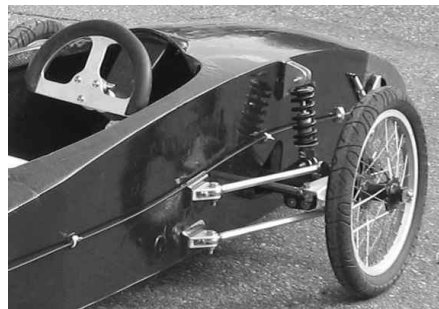
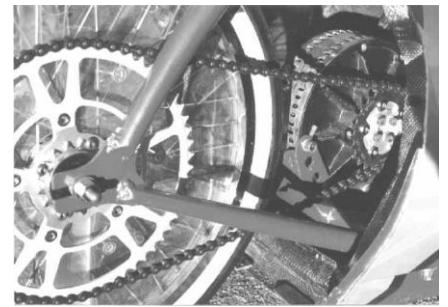
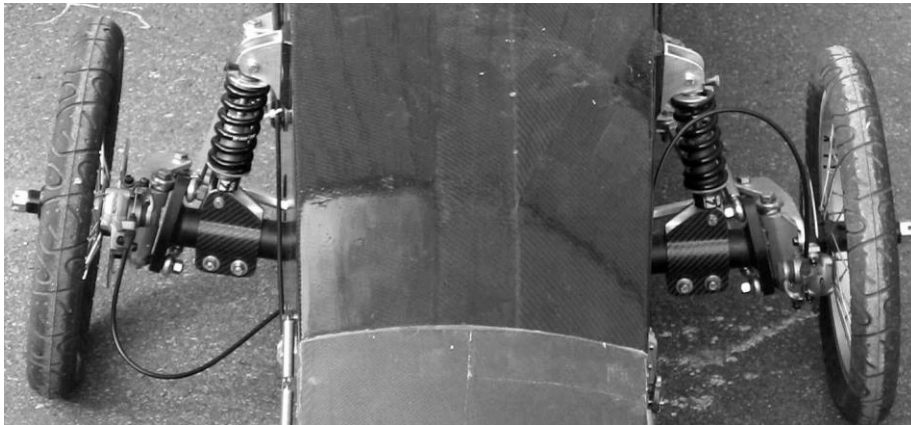

WHEELS

Most competitors use spoked bicycle, BMX or Moped wheels. Keep in mind that these two wheeled vehicles lean into corners, so the force is always straight down the wheel. If those wheels are side loaded, they need to be much stronger.

There is no minimum or maximum allowable tire diameter. If tires are too small, they do not work well on the road surfaces for Electrathon races. Tires of 10", 12", 16", 17", 20", 24", 26" and 27" have all been used with various levels of success. The larger diameter wheels have less rolling resistance, while the smaller diameter wheels have less wind resistance, and are typically stronger under cornering loads.

Spoked wheels should use heavy-duty spokes and lots of them. A good bicycle wheel mechanic can set you up with a very strong and light wheel. Remember to check them often for trueness and loose spokes. Wheel collapse is not uncommon, and a wobbly wheel won't go very fast. BMX type plastic wheels are maintenance free and quite strong (except at low temperatures), but heavier than spoked bicycle wheels and limited to lower tire pressure. Moped wheels are rugged and will take high tire pressure but weigh the most. While tire width and tread pattern are important, tire pressure is the biggest factor in rolling resistance. Obviously, the higher the better, but there are safety limits to consider. Choose the tires according to the track as well. Skinny tires work fine on smooth speedways but may not last the hour on a rough parking lot.

Wheel covers will reduce aerodynamic drag a great deal, as spokes tend to churn the air like egg-beaters. There are commercially available models, but they are not difficult to make in fabric or plastic. It is even possible to heat shrink mylar directly to the rim.

If you are industrious and have some experience with composites, you can mold your own dish wheels on aluminum bicycle rims. End grain balsa and structural foam have been used as core material. Carbon fiber alone is too brittle and should be reinforced with kevlar. It is also a good idea to cut out a simple flower or spoke pattern so some of the fabric layers can pass from one side to the other, forming an internal web. Remember to use some sort of uncompressable filler material where the bolts go through.

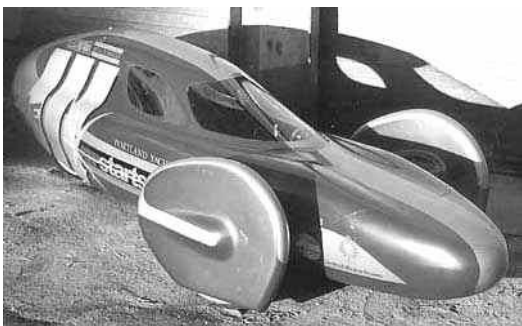

WHEEL PODS

They are called spats on airplanes and help to reduce the drag of an exposed wheel. Ever see the rooster tails flung from a wheel in the rain? The same thing is happening all the time in the air, we just can't see it. This turbulence greatly disrupts the airflow.

Remember, the top of the wheel is actually moving through the air twice as fast as the axle.

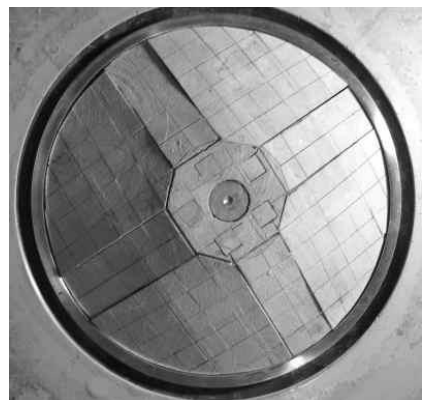

BRAKES

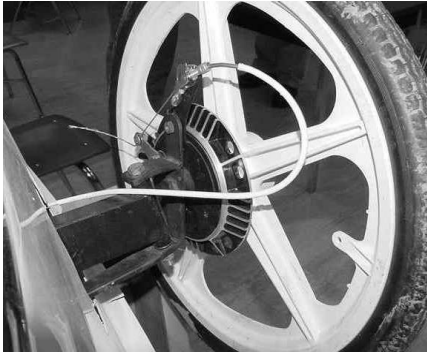

If you can't stop, you can't go. Nowhere are brakes more important than in competition, although most competitors use their brakes as little as possible. From a safety and liability standpoint brakes are vital. In competition, your ability to brake well will help you make that critical pass to win, or avoid a certain collision. In designing your chassis you must resolve how you are going to mount the brakes to your vehicle and what kind of brake assembly will work. Luckily you have a variety of options:

BICYCLE CALIPER RIM BRAKES

The typical bike brake can be mounted out on arms from your axle to grip the wheel rim. Offset arm style calipers can often be modified to reverse the cable so it pulls back along the wheel to the axle and then into the vehicle. Although this is the least expensive way to go, it is also the least effective, requiring ongoing adjustment and pad replacement to keep them working properly.

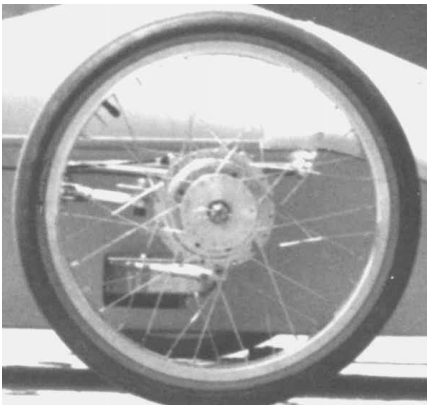

BICYCLE DRUM BRAKES

These are harder to find, but most bike shops can get them for you. They are used on tandem bikes since the pads don't wear out as fast. They must be custom mounted to your bike rims. Their large hubs and internal (automotive type) brake shoes make them a popular solution for Electrathon use. They do require adjustment though, and you must keep your spokes tight. Another variation is to use moped hub drum brakes. If you can, try a used set from an old moped. They are made from an aluminum alloy and can be adapted to fit bicycle wheels, or the entire moped wheel can be used.



DISC BRAKES

There are many disc brakes available now for mountain bikes and tandems, both cable and hydraulically operated. They are very light and strong but can be expensive. Go-kart discs are another option, however they are quite large, heavy and difficult to adapt. Small motorcycle disc brakes are also a possibility although large and heavy.

Whatever you use, make sure you can actuate them both evenly. If one side or the other locks up you will spin out or swerve.

AXLES



One important note: **DO NOT USE BICYCLE OR MOPED AXLES UNLESS SUPPORTED AT BOTH ENDS.** If your axles are cantilevered (attached on one side only like a wheelchair) you **MUST** replace the stock axle with a 1/2" or 12mm diameter bolt. Axle diameters less than 12mm are illegal. A bicycle or moped axle **WILL** break. It is easy to pull out the stock axle and replace it with a larger one. You must replace the wheel bearings with cartridge bearing assemblies. These can be found at bearing supply stores. Use an axle bolt and nut that accepts a cotter pin so your wheel doesn't come off. This is a rule requirement.

MOTORS

Most Electrathon vehicles use 12 or 24 volt motors although any voltage (36 volts and up) is allowable provided the total battery weight does not exceed 73 pounds of non-leaking batteries. Most motors are over 2 horsepower permanent magnet types. Series wound motors are lighter, but are not as efficient. Unloaded they can spin up and destroy themselves. Never let them rev free. Choose a continuous duty rated motor if you can, although small or intermittent duty motors can work but may require a cooling fan to prevent overheating. Not only does the fan use power, heat itself is energy - if your motor is hot, you are wasting it. Small motors running near their maximum current tend to get hot. Your batteries will give you about one horsepower averaged over the hour, but you can easily find yourself drawing 3 or more horsepower coming out of a tight turn. Pump, starter, forklift, surplus military aircraft motors and even generators can be found at low prices occasionally. Evaluate your motor carefully, talk to the manufacturer and other vehicle owners. Remember, your power comes from the battery, not the motor. Motors are only another place to lose energy on the way to the wheels.

MOTOR CONTROLLER

A P.W.M. (Pulse Width Modulated) type electronic speed controller is the best way to go. Although they are expensive, on tight tracks or where you must modulate power in traffic, they are beneficial and very efficient because they very rapidly cut power off and on to the motor. The controller is 'controlled' by a speed control, or potentiometer at the foot pedal, which operates at very low voltage to tell the controller how much power to send to the motor. This is often combined with another limiting potentiometer which sets a top limit on that power. This way you can drive with your foot to the floor and adjust the limit to the desired amperage, rather than trying to hold your foot at a precise point part way down for an hour.

Resistance type Rheostats absorb power from the motor creating heat. They are cheap but not as efficient. The simplest way is an on/off button, and can be fine on a fast track. You must be able to control power manually so that the power shuts off automatically when you release the throttle.

INSTRUMENTS

The goal of Electrathon is to see how far you can go in an hour. To do that effectively, you will need to know what your vehicle is doing, so instrumentation is essential.

Amperage and voltage are the most important things to know. Simple analog gauges will work, but it's hard to see the needle and small numbers when you are bouncing around in a race. Digital units (E-Meters) are more expensive, but they are much more precise, easier to read, and will record the data over time, so at the end of a race you can tell the total number of amp or watt hours you've used. Either way, your meter needs to be connected to a shunt, which is a chunk of metal of known resistance that current flows through.

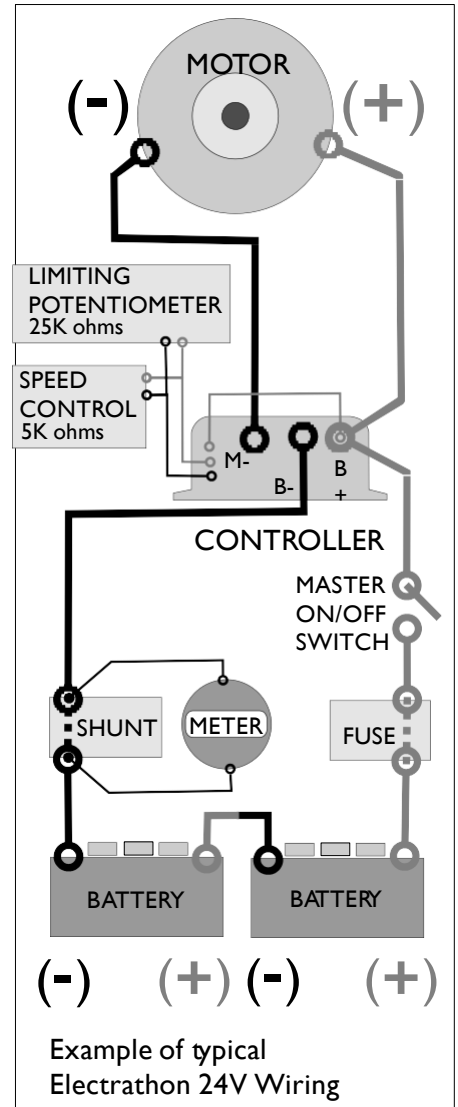

It is also helpful to know how fast you are going. Bicycle speedometers are inexpensive and offer a reasonably accurate measure of speed and distance, but remember, Electrathon distances are measured at the minimum possible for the course, not how fast or far **you** might have gone. Bike speedometers usually have another very helpful feature...a clock! If you do your calculations right, you can also use it as a motor tachometer, unless of course you are spinning your wheel (a definite no-no).

Electrathon America has tested these batteries to establish a reference point. Your actual results may vary

Optima SC25A AGM (SC35A
are the same with "reversed posts")
41.8 Amp/hours, 480 Watt/hours

Optima 75/35 AGM (Double Post)
38.9 Amp/hours, 447 Watt/hours

Exide Orbital 75/35 AGM
(Double Posts & built in Handles)
37.4 Amp/hours, 445 Watt/hours

Champion Vortex 75/35 AGM
(Double Posts & built in Handles)
35.8 Amp/hours, 415 Watt/hours

MK 40 amp/hr Gel Cell
21.5 Amp/hours, 233 Watt/hours

CHARGING

Battery chargers come in many sizes over a broad price range. 10 amp chargers are fine, they just take 6-8 hours to charge, where a 50amp charger can do it in 2-3 hours. 20 amps is a good compromise, and if it has a 24volt option, you can charge pairs together. Its better to charge them individually, though, as a weaker one will get weaker as you cycle them, and a strong one will get stronger.

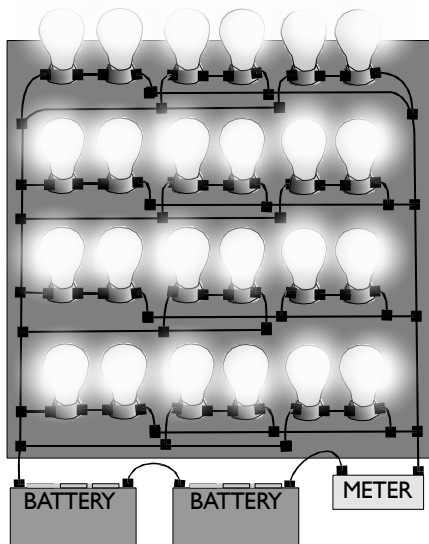

Typical 24V system test board

BATTERIES

Electrathon allows only non-leaking lead-acid batteries, with no more than 73 lbs. total weight. Batteries generally offer higher performance when they are warmer, so if you are racing on a cold day, it might make sense to heat them, at least to a level they were designed for, say a hot day in Arizona. Remember, batteries heat naturally when they are being charged or discharged, so keeping them in an insulated box retains more of their energy. Heating can be done with warming blankets, hair dryers, or immersion heaters. Hot tap water is often enough, as there may be diminishing return and permanent damage after 120 degrees (oven thermometers are a handy tool).

Batteries may be labeled as starter or deep cycle, although the distinction has become blurred in recent years and the cost is about the same.

Generally, starter batteries have more and thinner plates inside, so they will charge or discharge more quickly, but their useful life is shorter. The heating and deep discharging of racing is hard on any battery, but if you are kind to them (don't go below 21 volts and don't leave them drained for more than a day or two, even starter batteries should last a couple racing seasons.

Most lead acid batteries are 12 volt, and most Electrathon vehicles use two of them in series for 24 volts. It's the common compromise. Motors run more efficiently at higher voltages, but fewer batteries usually means more of the battery weight is "capacity holding material", not plastic cases and terminals. But Electrathon is all about creativity and experimentation, so anything is worth a try. Besides...technology evolves. While the basic idea hasn't changed much in a hundred years, manufacturers are trying harder than ever to improve them.

TESTING

The most important thing to know about your batteries is how much power they have. There is no way to know how fast you can go in an hour until you know how much power you have available. This is the Art (or Science) of Electrathon. To make an intelligent guess you need to draw them down over the course of an hour at a rate you think you can sustain. You can, of course, do that in the car on a track. Since this is not always convenient, or even possible, you can recreate those conditions in the shop. The simplest and most accurate method is to connect a test load directly to your car (and its meter). You will need something that uses power: 12 volt light bulbs (25 or 50 watt) work great, but you should wire them in pairs and test pairs of batteries together if you have a 24 volt system. Screw or unscrew bulbs until you draw the amperage you want. 36 amps is a good number. More than that and you've got a sure winner! To be more precise, you can keep screwing and unscrewing bulbs to maintain a constant draw (or just figure an average draw). Notice that the amps will drop as the voltage drops. This process also gives you a chance to plot the voltage curve. Record the voltage at even increments, say every 10 minutes. Having this data in the car can help you keep track of how much power you are using. A good set of fully charged batteries will show over 26 volts with no load. Under load that will drop to about 24 volts, and continue a slow drop to 21 volts. At that point they will drop rapidly, and continuing to drain them will cause lasting damage. While it shows admirable determination to keep a car going at walking speed, it can be expensive if it ruins the batteries.

RESOURCES

This is just a quick survey, and is not intended to be a promotion or endorsement of products or services. For more listings, go to www.electrathonamerica.org. Please contact us about suggestions for future editions.

LOCAL

These are the people you need to establish a relationship with. They have the expertise and the parts you need. They may even sponsor you by donating time and materials.

Bike Shop- wheels, tires, chain, sprockets, brakes, cables, bar ends, grips, speedometers, shocks, old frames, and forks

Hardware Store- nuts, bolts, and other fasteners, tools, metals, plastics, paint, tape, and especially duct tape

Battery Distributor- He sells batteries to all the local stores. Since what you are doing is promoting the wider use of batteries, it is in his interest to at least give you a good discount. Buy batteries locally; this is one item you *do not* want to pay shipping costs on.

Marine Supply Store- composite materials, batteries, switches, fuses and miscellaneous hardware

Motorcycle/Moped/Go Kart Store- Wheels, tires, brakes, helmets, seat belts

Machine Shop- there are critical parts, like motor and sprocket adapters that you can't buy... they have to be made

Body Shop, Welding/Fabrication Shop- If you don't have the expertise or space to work, they do.

Schools- Even if yours is not a school project, tech high school and colleges often have fabulous shop space, like machine, welding and body shops. If you can involve and inspire students, you may be welcome there.

BOOKS

Bicycling Science - Frank Rowland Whitt and David Gordon Wilson (MIT Press)

The Leading Edge - Aerodynamic Design of Ultra-Streamlined Land Vehicles Goro Tamai (Robert Bentley, Inc.)

Race Car Vehicle Dynamics - William F. Milliken and Douglas L. Milliken (SAE International)

Successful Composite Techniques - Kieth Noakes (Osprey Automotive)

The World's Most Fuel-Efficient Vehicle - Design and Development of PACcarII- Santin, Onder, Bernard, Isler et al Swiss Federal Institute of Technology/VDF

The New Electric Vehicles - A clean and quiet revolution Michael Hackleman (Home Power Publications)

The Winning Solar Car - A Design Guide for Solar Race Car Teams by Douglas R. Carroll (SAE International)

Electric Dreams - (story of high school kids building and racing an electric car) Caroline Kettlewell (Carroll & Graf Publishers)

ELECTRATHON KITS and PARTS

Blue Sky Design Rolling Chassis Kit
www.blueskydsn.com (541)895-5421 49

Cloud Electric Vehicles Components
www.cloudelectric.com (800)648-7716

SHIFT Electric Vehicles Kits & Parts
www.SHIFTEv.com (541)760-1895, accepts PO's

Electric Vehicles of America Inc Components
www.ev-america.com (603)569-2100

BS Designs Meter
www.brucesherrydesigns.com (206)909-3409

Enigma Industries Simulator
www.enigmaindustries.com

Lynch www.lemcoltd.com Motors

ALLTrax, Inc. Controllers
www.alltraxinc.com (541)-476-3565

Curtis Instruments Controllers
(914) 666-2791 www.curtisinst.com

Composites One Composites
www.compositesone.com

FiberGlass Supply, Inc. Composites
(509) 493-3464 www.fiberglasssupply.com

Aircraft Spruce & Specialty Composites
1-877-4-SPRUCE www.aircraftspruce.com

ELECTRATHON AMERICA

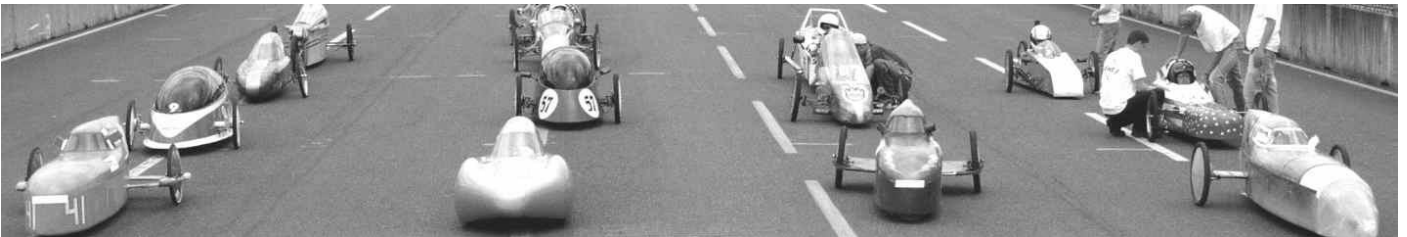
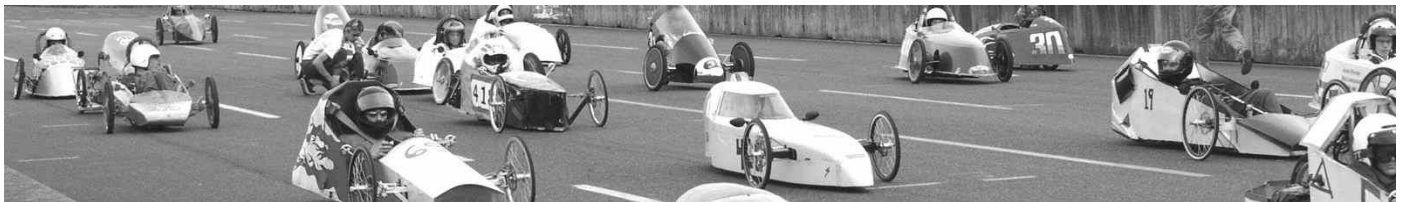
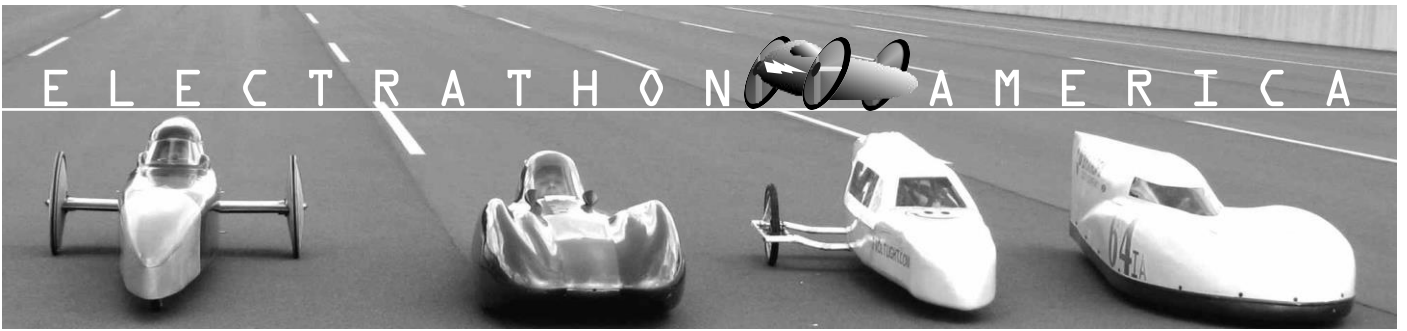

EVENT RULES

EVENT RULES

SANCTIONED EVENTS

Any Electrathon event may be sanctioned by Electrathon America provided that the event rules are upheld, and a sanctioning form is filed and accepted. Sanctioned events receive national publicity on the website, newsletter and secure adequate event liability insurance.

Sanctioned events assure competitors that official Electrathon America Event rules will be followed for fair competition and safety.

Events are held regionally around the country as well as championship events for road race, speedway and Velodrome. Championship event status is determined by event history, track quality and location by the Electrathon America Board

EVENT AUTHORIZATION

An Event Authorization Form (included in the back of this handbook) is mandatory for a promoter to hold a sanctioned Electrathon America Event. Event registration information should be provided to Electrathon America for posting on the National website Event Calendar. This can gain additional promotion for the event. A link can be provided to an Event Website if it is available.

EVENT INSURANCE

Insurance covering the Electrathon event is required to be sanctioned. Insurance may be purchased inexpensively through Electrathon America or secured independently by the Host or Promoter. If insurance other than Electrathon America's is used, then it must meet the minimum specifications listed in the insurance section of this Handbook. For events not using Electrathon America insurance, the host must provide Electrathon America with proof of adequate insurance to maintain sanctioned status.

EVENT INVITATION

A Sanctioned event should be open to all vehicles in a region, with invitations sent to all registered vehicle owners in that region. A list of registered vehicles and owners may be requested from Electrathon America.

Events may be limited in special cases, but it is recommended that everybody be invited, as we can all learn something from each other.

EVENT REPORTING

Records should be kept for specific track distance records for each class and division. Records, race results, photos and a write up of the event should be forwarded to Electrathon America for posting on the Website.

LIABILITY

All competing drivers must sign a liability release prior to entry (see Liability Release Form). If Electrathon America's insurance is used, the carrier requires their form to be used. Request these forms far in advance of the event.

The Event Design Rules are published by Electrathon America and are in force at all Electrathon America sanctioned events. These regulations are intended to provide a safe and equitable competition format and inspection process.



ELIGIBILITY

Participation is open to any individual, club or educational Institution complying with the event and vehicle regulations. Competitors must be members of Electrathon America

DEMONSTRATIONS

Demonstrations may be held where track size or allocated time do not meet the minimum requirements for a Sanctioned event. All other rules, especially those concerning safety must be observed. Vehicle speeds in demonstrations must not exceed 35 m.p.h. Entire events and/or Classes and Divisions within an event that do not meet Sanctioning requirements are considered Demonstrations.

There are no hardware differences between the High School and Open Divisions, which may include Standard, Solar, or Advanced Battery Class vehicles. In other words there are 6 different categories for potential winners and track records. With multiple heats, High School vehicles may be allowed to compete in both their own division and the open division.

SANCTIONED DIVISIONS AND CLASSES

Electrathon Divisions and Classes are created only for the purpose of awarding prizes. All Divisions and Classes are eligible to compete in any sanctioned Electrathon America race, allowing for multiple winners within the same race. An event is not required to have all combinations of Divisions or Classes to be sanctioned, but there must be a minimum of three vehicles in each Class or Division for that category to be sanctioned. The Race Steward may decide it is safer, if time allows, to reduce the number of vehicles in a race by creating multiple races, or heats. Separating the competitors by Division or Class is a convenient way to do that, but it may be safer to divide them according to potential or proven speed.

SIX MAIN CATEGORIES THAT COMPETE SEPARATELY EVEN IF THEY ARE IN THE SAME RACE

HIGH SCHOOL DIVISION

STANDARD CLASS / SOLAR CLASS / ADVANCED BATTERY CLASS

OPEN DIVISION

STANDARD CLASS / SOLAR CLASS / ADVANCED BATTERY CLASS



HIGH SCHOOL DIVISION

High school owned vehicles or vehicles built by High School age students with instructor supervision of student driver(s) and crew.

OPEN DIVISION

Vehicle owner(s) and driver(s) may be any individual, college, university or corporate team.

STANDARD CLASS

The Standard Class is viewed as a lower cost alternative in keeping with the spirit of Electrathon competition and actually represents what is typical for the majority of vehicles built.

SOLAR CLASS

The Solar Class allows the use of photovoltaic cells to provide additional power during a race. In most cases that additional power will be more than offset by the increased weight and aero drag of the cells, and while the cost of PV cells is usually prohibitively expensive, they are often donated to schools. It was also felt that solar power offers a sustainable alternative to conventional energy sources and fit the general objectives of Electrathon.

ADVANCED BATTERY CLASS

The Advanced Battery Class is intended to foster experimentation with newer battery technologies that offer higher energy density than lead-acid, and reflect the rapidly expanding availability and usage in the transportation industry. The various weight limits are meant to keep the available power under one kw/hr, or about the same as the current Standard Class.

DRIVER CHANGES

As a suggestion only and not a rule requirement, a race steward has the option to require the following: Sometime between 20 and 40 minutes into the race each individual vehicle must stop at a designated and supervised location and the first driver exits and a second driver enters and drives the rest of the race. If there is not another driver available, the vehicle must still stop, and the driver exit and re-enter. The ballast should be calibrated for the lighter driver.

This variation encourages more participation and reduces driver fatigue.



ADDITIONAL CATEGORIES

Event organizers may create additional divisions as needed by their particular area or participant mix. This may only be done for the purpose of equality of competition and not for the gain of specific teams or vehicles. Additional divisions with an explanation of their requirements must be noted on the Event Sanctioning form when it is submitted to Electrathon America. Some of the additional categories that have been used in the past are: Kit Car Division (vehicles build from purchased kits), Novice Division (new vehicles in their first event/season), College Division, and combinations of Experimental Class vehicles (such as solar with advanced batteries vs. lead acid).

COURSE REQUIREMENTS

Events are typically held on parking lots, paved race tracks or velodromes where access onto the track can be safely controlled.

EA strongly encourages events to be held on actual race courses when possible. This is to alleviate hazards inherent in street courses. Where road or parking lot courses cannot be avoided, extra care should be taken to identify possible hazards and have them barricaded or flagged to prevent collisions. Such hazards shall be identified and strategies for avoidance discussed at the drivers meeting

Courses must be closed to all other vehicular traffic. Adequate precautions must be taken to prevent access onto the track. This may include, but not be limited to, signs, barricades, banner tape, and traffic cones.

Power should be provided at a rate of two-120 Volt, 20 Amp circuits per 10 cars. Power should be continuously available from 3 hours before the competition starts to 3 hours after the finish.

A pit area should be provided adjacent to the track with adequate area for displaying and charging the vehicles and accommodating support vehicles. If a display area is not adjacent to the Pit/Track, then there should be power in both the pit and display area.

Courses should be free of obstructions such as chuck holes, speed bumps or protrusions that would create a hazard to the competitors. The entire course surface should be the same material and texture. Dips or bumps which may damage the vehicles must be corrected or sanction will not be possible.

Barricades must be provided to define the course and may include traffic cones, saw horses and police tape and/or hay bales, etc. Courses should be clearly marked to identify all corners, boundaries, start/finish and any obstacle that could pose a safety problem.

There must be a positive physical barrier between spectators and the course. The barriers surrounding the course must be sufficient to stop Electrathon vehicles. Street curbs are not an effective barrier. Hay bales, tire walls, or suitable barriers must be provided to separate the course from spectators. Spectators must not be allowed near the course. Specified spectator areas should be designated with signs, barriers, or at minimum marking tape. There must be enough personnel/security provided for crowd control.

Road Course layouts should be designed to offer a variety of turns and straights unique to the location. Courses from 1/4 to 2 mile lengths are used.

Courses should alternate from clockwise to counterclockwise from event to event, to reduce tire wear, vehicle stress and offer variety. However some race tracks are specifically designed for vehicles to travel only in one direction. Do not run in a reverse direction if it compromises safety in any way.

Courses should be of adequate width and length to safely accommodate all competitors and allow safe opportunities to pass and maneuver. If a course cannot handle the number of vehicles present then separate heats should be run with a safe number of vehicles in each heat.

LENGTH

MINIMUM COURSE LENGTH FOR A SANCTIONED EVENT:

Flat Course:

1/4 Mile (1320 feet, 402.34 m)

Banked Course:

1/4 Km (820.21 feet, 250 m)

Courses should be long enough to permit vehicles to attain their top speed at some point on the course. A 500-700 foot straight is desirable.

Course length must be measured with a measuring wheel. On an oval track the distance is measured as the minimum distance a vehicle's inside tire could travel. On a track with reverse turns, the distances are measured with tangents from inside turn to inside turn.

The distance covered by a vehicle in one hour may be determined by an alternative method if that method can be shown to be more accurate than the current method, and has prior approval from the board of directors. An alternative method may be used to determine an official record of distance/time, but may only be used to determine the finishing order of a race if every competitor uses the same method.

WIDTH

RECOMMENDED MINIMUM COURSE WIDTH: 25 feet

Course width must be free of obstructions such as cones, barriers and channels. Surface must be same across entire width. There may be no obstacles in the entire course width which would limit the free movement of any vehicle from side to side.

RADIUS

MINIMUM CORNER CENTERLINE RADIUS : 25 feet

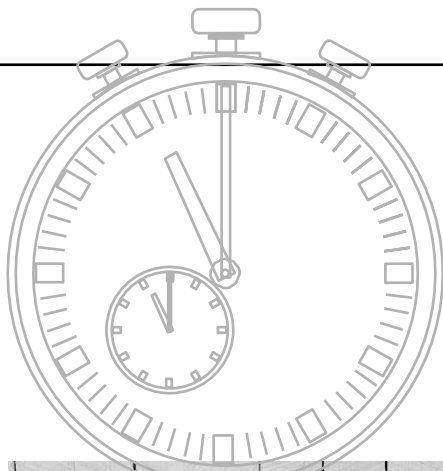

For example; If there is \$500.00 in prize money and the total laps achieved by ALL of the cars in the event is 1000, then the per lap rate is $\$500.00 / 1000 \text{ laps} = \0.50 per lap . If car # 1 completed 156 laps during the event, then it's owner would be paid $\$78.00, (156 \times \$0.50)$.

For example; There are 40 vehicles competing, 10 in the Open Division and 30 in the High School Division, and the total prize money is \$1000. The Open Division's portion of the prize money would be $1/4 (10/40)$ of the total, or \$250. The High School's portion would be $3/4 (30/40)$, or \$750. If the 10 Open cars completed 500 laps, then the per lap rate for them would be $\$0.50 \text{ per lap}$. If the 30 High School cars completed 1250 laps, then their per lap rate would be $\$0.60 \text{ per lap}$.

TIMING AND SCORING

An Electrathon race is one hour in duration, with a maximum of two minutes allowed after that time for each vehicle to complete its final lap. At exactly 60 minutes by the official clock the checkered flag is dropped. Any vehicle that crosses the finish line before that time may continue until they cross the finish line again. If they complete this final lap within the additional two minutes that lap will be counted, if they do not, it will not be counted. Finishing position may be determined by observing the order vehicles cross the finish line on the final lap or recording the time it took to do so.

ENTRY FEES

Event host organizations may charge entry fees to events. Use of such entry fees are at the discretion of the host organization. It is recommended that prizes, trophies or awards be offered. It is assumed that registration/entry fees will be used to cover event costs, although excess monies should be paid out as prize money in addition to any sponsor provided prize money. A promoter may award trophies, plaques, product prizes, etc. for performance, and prizes may also be awarded for sportsmanship or educational achievements.

PRIZE MONEY

AWARDS

Electrathon America believes the distribution of prizes should be among all the participating vehicles and based upon performance. We do not feel a "winner take all" philosophy is in the best interest of this sport. All prize money or cash awards shall be distributed among all participants on a per lap basis. Non-cash awards, trophies, certificates etc may be distributed as deemed appropriate by the event promoter or sponsor. Payouts should be distributed to the vehicle owners as soon as possible after an event.

PER LAP PAYOUTS

Total prize money (lap money) is the total of the registration fees (minus the share to cover expenses) plus any separate prize money that has been donated to the event. Prize money is based upon laps completed by each vehicle. The total prize money is divided by the sum of all the laps completed by all the vehicles during an event to arrive at a per lap rate. Then each vehicle's lap totals are multiplied by the per lap rate to arrive at a per vehicle pay out.

PAYOUTS WITH MULTIPLE CLASSES/DIVISIONS

To maintain prize payout equality between the Classes and Divisions it is important that the prize money be divided proportionately. It would be unfair for all participants to pay the same entry fees and have one Division or Class take home a majority of the prize money. When multiple categories are competing the total prize money should be proportionately divided by the number of vehicles competing in each category before the per lap rate is calculated. This way the first place Open car, the first place High School car, and the first place Solar, for instance, would receive almost the same amount of prize money.

VEHICLE INSPECTION

All competing vehicles must conform to current Electrathon rules.

At the discretion of the event Steward, vehicles with minor non-compliance of performance regulations may be permitted to participate on a one-time basis provided that the issue(s) of noncompliance does not compromise safety. Non-compliant vehicles are not eligible for lap money or prizes and are not included in the official results.

All vehicle owners must present their vehicles for inspection prior to the event. It is the vehicle owner's responsibility to allow enough time for inspection and any designated repairs or modifications. Competitors are expected to inform themselves of the current vehicle design rules.

Vehicle drivers must also present themselves for inspection, for clothing, weigh-in, and vehicle exit test.

Battery weight inspection is an important part of Electrathon competition. Since the batteries are what limit the performance of specific vehicles it is important that battery weights be accurately measured. The Event Coordinator shall provide an accurate scale capable of weighing up to 73lbs. This one scale shall be declared the official scale and all batteries must be weighed on this single scale.

It is recommended that the scale be calibrated using a 'weight standard'. Such a standard can be as simple as gallon jugs of water. The amount of water in one of the jugs must be altered to make the total match the current weight limit as defined in the rules section. To create the standard, use a state regulated calibrated scale such as those in the meat or deli departments of grocery stores. These scales are checked periodically with extremely accurate equipment by the state to ensure that they weigh accurately.

Inspections will be performed as per the INSPECTION CHECKLIST by the event Steward or an official inspector designated by the Steward.

No disqualification of a vehicle can be the sole decision of an inspector. Disqualifications must be made by a joint decision of the inspector and the Steward. Inspection decisions are the sole responsibility of the Steward.

The Steward may at his/her discretion inspect any vehicle following any competition. Post event inspections may be for checking ballast, battery weight, type, or for safety issues. These are examples of possible inspections and is not a comprehensive list.

DRIVERS AND TRACK PERSONNEL MEETING

The Event Steward gathers all the Drivers and Track Personnel including the Timer, Spotters, Lap Counters and Course Marshals together and explains the event procedures including:

1. Ensures all drivers have registered and vehicles are inspected.
2. Explains roles of Timer, Spotter, Lap Counter and Course Marshals.
3. Meaning and use of the flags
4. Starting Procedure
5. Special Course Instructions
6. Answers all questions
7. Tells the drivers when to bring their vehicles to the Starting Grid.

COMPETITION FLAGS



GREEN
(start):
Competition has begun..

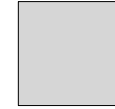

YELLOW
(caution):
Drivers need to slow down and proceed with caution. A corner marshal shall only wave their yellow flags if there is an immediate danger within a reasonably close distance beyond the corner that drivers need to be aware of before the corner so they can avoid the danger. No one else on the course needs to wave a yellow flag unless dictated by race Steward as necessary due to race track conditions.



RED
(stop):
All vehicles stop at the Start/Finish line but remain in order and the clock is stopped until the race resumes. May also be displayed at 62:00 to confirm race is over.

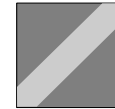

BLUE
w/**YELLOW STRIPE**
(passing):
You are being overtaken. On a road course; drive predictably. On an oval or velodrome; move to the innermost portion of the track so you can be passed.



BLACK:
Your vehicle must stop in The pits. A furled black flag may be used by the Steward to warn drivers of violations before forcing a full black flag and a pit. This use is limited to small violations not causing safety issues on the track. It would only apply to issues which the driver could correct while on the track, such as poor driving.



WHITE:
*Two minutes left in the competition.
58:00 to 59:59*

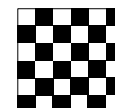

CHECKERED:
*Competition is over.
Pull off the track after crossing the finish line.
(60:00 to 62:00)*

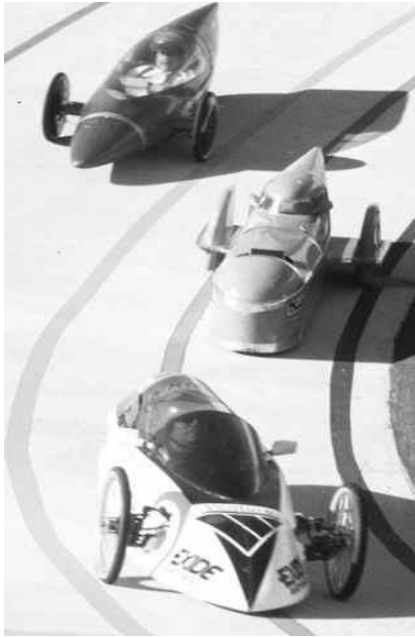

SPECIAL VELODROME EVENT RULES

Vehicles should be positioned two abreast at the starting line on 8 foot centers.

All vehicles must pass on the outside (to the right if counter clock wise, to the left if clock wise).

A vehicle that passes on the inside will have one lap deducted from its score for each vehicle it passes illegally. If the pass is under yellow and the vehicle drops back to its correct position before the yellow is lifted, there is no penalty. It is the responsibility of the event Steward to signal vehicles which are not staying to the inside by using the BLUE and YELLOW STRIPED FLAG.

All vehicles must drive on the inside portion of the track. Vehicles may only move to the outside to pass. Upon completing a pass a vehicle must move back to the inside portion of the track. The level lane that exists in most velodromes is not considered part of the racing portion of the track and is used only for entering and exiting the track.

It is recommended that all vehicle owners verify that their vehicles are stable on the velodrome steep banks. Typical angles are 22 degrees to 33 degrees.

STARTING GRID

The Steward will ensure that all vehicles have sufficient braking power right before starting a competition. A brake push test must be performed on every vehicle once on the starting grid.

Starting positions are determined by one of several methods. The Event Steward decides the method. The method chosen should be announced prior to the event so that teams can be prepared.

- * Pick at random by drawing numbers from a hat
- * Place in order based on receipt of entry forms
- * Place in order based on the completion of Inspection
- * Place in order based on standing from previous Event or Series total
- * Place in order based on practice or qualifying speed. While these speeds may have no relationship with finishing order, placing faster cars in front makes for a safer start.

Vehicles should be positioned at the starting line on 8 foot centers minimum. The number of vehicles in each row is determined by the width of the track at the starting line. The Pole position is in the front row on the side of the inside of the first corner. Successive rows line up abreast behind the first.

If all competitors cannot be safely or fairly accommodated on the starting grid, the Steward may elect to divide the field of competitors into two or more heats. These heats will be considered the same event and should be awarded and scored together. Dividing the field according to apparent or potential speed rather than class or division will reduce the speed differences on the track and make for safer racing.

VIDEO CAMERA

A video camera must be placed at the Start/Finish Line and record entire competition. This tape will be used in the event of lap count protest. The Camera should have a wide angle lens and be placed far enough back from the track to afford a good field of vision but close enough to be able to reliably identify all the vehicle numbers. The camera may be elevated above the track for the best viewing angle. Recording must begin before the green flag is dropped and must remain on until 2 minutes after the checkered flag is displayed. Time and date should be displayed continuously if possible.

COMMUNICATION

Some method of communication between the race steward and all course marshals is required for a race to be sanctioned. If the course is small enough to allow clear visual contact, hand or flag signals will suffice.



EVENT ROLES AND RESPONSIBILITIES

PROMOTER

Must adhere to the Electrathon America Rules and recognize that Electrathon represents a distinctive and well-defined class of vehicle and competition in the U.S. The purpose of Electrathon is to promote a positive attitude and educational benefits in the participants and public with regard to alternative electric vehicles.

EVENT COORDINATOR (MAY BE PROMOTER)

The Event Coordinator is the contact between The Electrathon America Organization and the Host Organization that is presenting the event. The Coordinator negotiates the conditions of the event including; location within the site, times, prize money, if available, course size, shape and physical requirements such as power, barricades, support vehicle access, etc. This person must verify all drivers and vehicles have Electrathon America Competitor Membership and collect fees for any which are not. Fees must be sent to Electrathon America. The Event Coordinator may also be the Steward as long as his/her own vehicle is not entered in the event. The Event coordinator may have a vehicle entered, and even drive in the event they coordinate as long as they appoint an independent Race Steward.

STEWARD (MAY BE EVENT COORDINATOR)

The event Steward is in charge of the competition itself and is responsible for the following:

- * Conduct or supervise vehicle inspections
- * Assign volunteers
- * Run driver/track personnel meeting prior to the race.
- * Supervise the race. The Steward may be the Flagman or may appoint a Flagman, who, like the Course Marshals, acts under his/her supervision.
- * Verify lap totals and scoring

The Steward observes the competition in progress, the conduct of competitors and the condition of vehicles. The Steward has final authority on all disputes regarding Event issues and rules. Protests not resolved by the Steward may be submitted to the Board of Electrathon America. (See Forms). The Steward should be experienced with Electrathon events but should not have a vehicle entered in the event they steward.

INSPECTORS

Persons knowledgeable of the Electrathon Vehicle Design Rules and Electrathon vehicle construction may be appointed as inspectors. The Inspector will scrutinize each vehicle entry for compliance to the design rules. Particular emphasis is placed on issues of safety. The inspector shall use their fair judgment regarding compliance to the rules. Disputes on inspection decisions should be taken to the Steward.





TIMER

The Timer "STARTS THE CLOCKS" as the green flag is dropped and continues the clock unless the event is stopped by the Steward. The timer must have a back-up watch running in case of failure of the main clock. It is the Timer's responsibility to inform the Steward of important time increments. The Timer uses a whistle to announce each ten minute time period of the competition, and calls out each period as well verbally. This is also done at 59 minutes, at 60 minutes and at 62 minutes.

LAP COUNTING

Electrathon America allows and encourages the use of an electronic counting system. Hand counting a race can be easier with only a few cars, but any form of hand count becomes unreliable when counting larger venues such as a 50-car race on a half-mile track. Electronic systems have actually broken ties between two cars in two separate heats that had less than one second between them that would have been nearly impossible with any form of hand count.

When Electronic Lap Counting is being used, anyone wishing to transmit data or use wireless cameras shall notify the race marshal before the race and must receive written approval on registration form.

Hand Counting Method Examples :

Individual Lap/Time Sheets (Preferred Method)

If the Individual Lap/Time sheets are used the Timer will start the clock that all Counters will use. It is best if you use one person for each vehicle. An excellent method is to use the time display of the video camera by connecting it to a large monitor. Each time a car passes the Start/Finish line the actual clock times are entered in the next open box. This method allows all lap times to be calculated and is a better system for resolving lap disputes.

Multiple Car Lap Sheets (Requires less personnel)

A minimum of two teams, each with one SPOTTER and LAP COUNTER, is positioned on opposite sides of the start/finish line (if possible). The longer the course the more cars each team can reliably count. The field of cars is divided between the scorekeeping teams by consecutive numbers. A maximum of six cars per team. Add more scorekeeping teams as necessary. The SPOTTER calls out the number of each assigned car as it passes the start/finish line, to the LAP COUNTER who checks off the car in the appropriate box (see scorekeeping tally sheet) based on the car number and time period (the tally sheet divides the competition into ten minute intervals). At 60 minutes, by the Timers watch, and by announcement of the Timer, no more checks are added to the tally sheet. All scorekeeping teams then record the order of finish of all the vehicles crossing the start finish line by vehicle number, until each vehicle number has been written down once, or two minutes has elapsed. The car order record is used to determine the order of cars on the same lap. This extra lap record is included with the total number of laps completed.

COURSE MARSHALS

Marshals are assigned to specific positions around the track. They may be issued a yellow caution flag, passing flag, or whistle. It is their responsibility to keep the track safe for the competitors. This includes:

- * Warning approaching drivers of obstructions on the track such as disabled vehicles or accidents.
- * Assisting drivers in distress.
- * Keeping spectators off the track and out of dangerous locations.
- * Informing the Flagman of hazardous situations

It is required for a sanctioned race that there must be some method of communication between the steward, flagman and all course marshals.

ADDITIONAL VOLUNTEERS

Assigned duties as needed, such as parking, sign-up, concessions, info booths, admission, photographer, etc.

ANNOUNCER

The Announcer should be familiar with Electrathon vehicles, the vehicle entries and driver names, as in all spectator sports, the Announcer excites the crowd, and helps them understand and follow the events on the track. The Announcer should offer humor, insight and entertainment and help generate interest in Electrathon.



COMPETITION NUMBERS

Vehicles in each region will have their own set of three digit numbers to be registered with Electrathon America. Available numbers range from 001 to 999. The first and second numbers can be "0" such as "007" but that will be considered the same number as "07" and "7". In the case of numbers such as "007" the preceding "0"s need not be displayed on the vehicle.

There can be no duplication of numbers within a region but the same numbers can be used in other regions. If two vehicles from different regions, but with the same number, compete at an event, the vehicle from the visiting region will be re-numbered (for this competition only) by the event Steward.

All requests for numbers in all regions must be made to the Electrathon America as part of a new paid membership or a renewal of an existing membership. If a membership renewal is not paid the competition number may be re-assigned to another vehicle if it is requested.

Once you begin construction of your Electrathon vehicle, and certainly by the time you complete it, you should request a competition number for your vehicle. You may ask for a specific number(s) if they are not already held by someone, or a number can be assigned to you. Please provide three choices on your membership form. Your first choice may already be in use in your area.

The numbers have no performance rating, that is, they do not mean anything as far as ranking in Electrathon competition. Any vehicle can keep its number as long as the membership dues are paid each year.

If you arrive at an event with numbers of your own choosing you may have to change them before competing if that number is already in use by another competitor that registered it with Electrathon America.

Once you request and receive a number assignment with your paid membership, your vehicle is automatically registered with Electrathon America. You will receive information about events and are considered a member of Electrathon America. You may be asked to vote on rule change issues, and may request, or be asked to serve on the Board of Directors if an opening exists. You may be asked to serve on various Electrathon committees, and should support the sport by helping promote Electrathon and assist at events in any way you can. A good organization means participation.

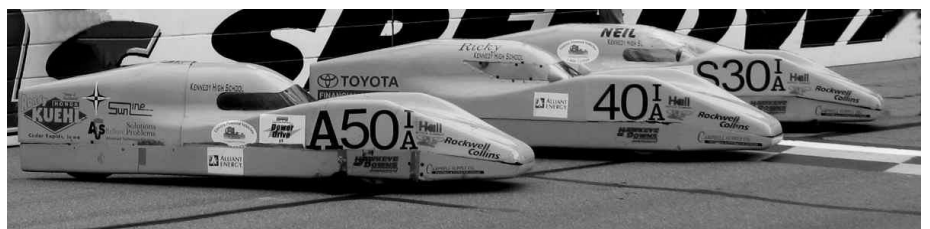

RULES OF THE ROAD

It is completely contrary to the sport of Electrathon for vehicle to vehicle contact to take place during an event. Intentional contact with another vehicle will result in an immediate black flag and disqualification.

Failure to remain aware of the surrounding vehicles as evidenced by repeatedly cutting off, taking a line away from a faster vehicle, or other such negligent behavior, shall result in an immediate black flag and removal of the offending driver. The vehicle may continue with an alternate driver that meets all criteria as a driver for the event.

Vehicles traveling at less than 1/2 their original speed may be removed at the discretion of the race steward if they consider the vehicle to be a safety hazard.

Any vehicle that loses its driver's ballast weights onto the track will be immediately black flagged and disqualified.

SPORTSMANSHIP

All persons associated in any way with an Electrathon America event are expected to conduct themselves in a cordial manner. Confrontations or arguments will not be tolerated and participants are subject to disqualification.

PENALTIES AND DISQUALIFICATION

At the sole discretion of the event Steward, any vehicle or driver or team member may be disqualified from competing at an event. Disqualification may be issued for flagrant violations of sportsmanship, deliberate cheating, or anti-social behavior.

Stewards may disqualify or penalize participants for safety violations, poor sportsmanship, or violations of either the design or event rules. These examples are provided as guidelines to help determine penalties for unspecified infractions.

- * Lap penalties for small infractions
- * Heat or Day disqualification for competition violations such as no ballast, cheating, or competing unknowingly without brakes.
- * Event disqualification, forfeit of lap money or entry fees, for safety violations such as knowingly competing with faulty safety equipment, or multiple or second violations after being warned previously.

DISPUTES OR GRIEVANCES

Any driver believing a fellow competitor has violated the Vehicle Design or Event Rules may file a protest immediately after the event. (see protest form sample). Such protests should limit themselves to issues where a clear illegal advantage was gained that affected the outcome of the event. Protests must be filed with the Event Steward. A protest fee of \$25.00 is required, and will be returned ONLY if the protest is upheld.



EVENT INSURANCE

Electrathon America has secured an insurance policy to cover Electrathon America Sanctioned events nationwide. Electrathon America paid the initial minimum premium for the policy, this allows events to buy into the policy if equivalent coverage is not available otherwise.

To get insurance follow these easy steps:

- Start early
- Read the requirements below
- Determine the insurance requirements of your venue
- Mail in your application
- Mail your payment (must be received before event and before certificates are issued)
- Enjoy your event!

Insurance can only be extended to Electrathon America Sanctioned events. To obtain sanctioning, complete the AUTHORIZATOIN FOR A SANCTIONED EVENT form, available at ElectrathonAmerica.org.

Requirements:

Events must be sanctioned by Electrathon America

Submit applications for event coverage 4 to 6 weeks prior to event.

A diagram of the course layout is required for parking lot and street events and any other events not in a standard auto racetrack. Photographs may be mailed or emailed if required.

Generally, events in parking lots or on the street will require some sort of positive barrier protection (tires or hay bales) and crowd control fencing (generally, orange plastic snow fence is acceptable) to prevent spectators from entering restricted areas or the course.

Events at standard race tracks may not need diagrams and detailed information. Call the insurance agent to determine if this is a track known to the underwriter.

Two waiver forms are required: One for every entrant to restricted areas, the other for minors who participate or enter restricted areas. These must be ordered more than 2 weeks prior to the event. Late orders will be charged for express mailing.

Each minor and his/her parent or guardian must complete a waiver.

Funds must be received prior to issuing certificates of insurance.

Funds must be received prior to the event to prevent cancellation of the event coverage.

Event Insurance available from Electrathon America:

Contact Electrathon America for current pricing and further details.

Insurance Request Form is online at: ElectrathonAmerica.org

Additional Available Coverages:

Higher limits of coverage may be available if needed by a specific venue.

Contact Electrathon America for more information.

Annual practice, Club meetings, Social Functions, concours, etc. may also be covered for an additional premium.

Additional insureds

List the additional insureds, as required for your event, on the application.

Automatically included as additional insureds are:

- A. Any person or organization engaged in operating, managing, sanctioning, or sponsoring the "Covered Program" or providing the premises for a "Covered Program", including officials of the "Covered Program"
- B. Any participant, (excluding drivers) "Competition Vehicle" owner and "competition vehicle" sponsor and officials of the "Covered Program"
- C. Any "participant" driver, but only with the respect to " Bodily Injury" or "Property Damage" to persons other than any other driver.

EVENT CHRONOLOGY

Suggested Times and Procedure for hosting a Sanctioned Electrathon America Event

3 months before the event

Find a location for the race.

This can be anything from a parking lot or an actual track. (Read COURSE REQUIREMENTS p.30) Parking lots are often free, but so are small local speedways, which are unused for much of the week and the off season. Larger race tracks are in use more often, but can be available to non-profits like Electrathon. Race tracks are for racing, they do not have hazards like light poles, curbs, manholes and stone walls. They also have clearly delineated areas for racing and spectators. Parking lots require all the hazards to be protected, the course and spectator areas to be defined and enforced.

Find a sponsor.

This is not required but can greatly help with costs. They can help pay insurance and other fees, offer prizes, help with publicity, and reduce or eliminate entry fees. Be specific about what you can offer. Some will be happy with a thank you and a credit somewhere, others want their name in lights. For a big event, or a race series, posters, flyers, signs, and t-shirts are a great opportunity for a sponsor. The shirts can offer a reward to the participants and volunteers, and selling might offset costs

5 weeks before the event

Obtain insurance for the race. Complete and submit the Insurance Request form (offered on www.ElectrathonAmerica.org) with payment. If using other insurance, send "proof of insurance" including coverage details.

Obtain Electrathon America Sanctioning. The Sanction Request form is offered on www.ElectrathonAmerica.org. Once this and Insurance are approved, you will be notified of sanctioning approval, and event details posted on the Electrathon America event calendar.

Obtain Insurance Waivers for racers. Request quantity of insurance "waiver forms" needed. At least one for each racer.

1 month before the event

Publicize Your Event.

Get your event on EA web site calendar and be sure all data is correct well before actual race. Have firm times for all aspects of the day. Sending out a flyer or poster to all local Electrathon teams is a great idea and increases turnout. EA can help with a list of members in your area, Be sure to include dates, times, location (directions and maps), course description, registration costs, prize money, local hotels, and any information special to your event. Contact local TV, newspaper, and radio. It draws a crowd and makes the race more exciting. It also helps with sponsorships in the future.

Week of event

Choose Key Personnel.

Confirm commitments for Race Steward, Inspectors, Flagman, Timer, Lap Counters, and if possible, an announcer.

Meet with Key Personnel (preferably on-site)

Draw map, make schedule and compile list of responsibilities. Make sure everyone knows the layout, the schedule, the procedures, and their role in it. Confirm the source, responsibilities and commitment of assistants and volunteer workers. Decide on what materials will be needed and where to get them.

Get Materials together.

Have all safety barricades, fences, cones, signs, flags, scales, clocks, tents radios, sound system, transponders, etc., available and accessible. Confirm vendors, volunteers, and supplies, like clipboards and inspection materials. Print out all the Inspection, registration, lap counting, and other forms that will be needed.

EVENT CHRONOLOGY

Make every effort, on race day to stick to the schedule. Otherwise it gets worse and further behind as the day goes on. People have things to do and no one wants to race after dark.

Morning of event

Set-up

Do this very early in the morning or the day before if possible. Set safety barriers around hazards, set up fence or other crowd control. Define the race course with cones, etc. Set up any signs/banners, tents, timing gear, sound system, etc. that you planned.

3 hours before event

Tech Inspection

Deadline for Registration of entries, Begin Inspection of vehicles and drivers. Inspect all new cars completely using appropriate inspection sheets. (see check off sheet in handbook) Look over all pre-inspected vehicles if part of a race series to be sure it is still safe. Look over at inspection sheet from 1st race to see notes etc. (these should travel race to race) Ask about changes since last race and not on inspection sheet. Look to see if things still look okay and if not inspect that area as if it were new. Weigh drivers, ballast, and if necessary, batteries.

2 hours before event

Qualifying (if required)

Have anyone 16 and over without a driver's license perform a 10-minute qualifying run at race speeds, supervised, and approved by the Race Steward, or an official appointed by him, who is not affiliated or related to driver's team(s).

Set up Lap Counting, Timing and Video Camera(s)

Explain lap counting procedure and provide materials to volunteers, install transponders, if they are to be used.

1 hour before event

Drivers Meeting

After cars are inspected, Race Steward and/or Flagman calls to order with all drivers stepping forward. Everyone else steps back, except corner marshals, who form a group for specific instructions. Discuss items you want to stress before race, including: remind drivers here is to be no contact between vehicles, and what the penalties will be; describe the proper passing techniques; point out challenging or dangerous parts of the course. Go over the flags, where they will be, and what they mean. Draw for starting position if this is the method to be used.

1/2 hour before event

Race Vehicles moved to starting grid

Divide vehicles into heats and assign starting positions according to the pre-determined procedures.

Track personnel, in position

Corner marshals, etc, move to their designated location,

Clear the track.

Public announcement to all spectators and non-essential personnel to clear the racetrack.

5 minutes before event

Drivers in Vehicles

Track is Ready

Confirm that Track Personnel, Timers, Lap Counters and Video are ready, Photograph the entire starting grid for documentation.

Drivers are ready

Confirm that all drivers are belted in and ready to start.

Start

Announce the race and drop the green flag.

EVENT CHRONOLOGY

Ending the event well will make all the participants and supporters feel the race was well organized and they will want to return or help out in the future.

Immediately after the event

Tally the results

List all the finishers, the number of laps they completed, and their finishing order as soon as possible.

Begin clean up

While the results are being compiled, begin the removal of safety barriers, etc.

Awards Ceremony

If awards are being given out, hand them out as soon as the results are available after the race. Begin the ceremony by thanking the sponsors, location hosts, and all the volunteers who made it possible. If you are giving lap money, find the total number of laps in the race and let racers know how much money per lap will be given out. Take photos of the teams and the winners.

Immediately after the awards ceremony

Complete clean up

A thorough inspection insuring that everything is removed and all the trash picked up will help in having more races in this location.

Cancellation

Race Day Cancellation

Send email and if possible, call Electrathon America Secretary with cancellation prior to racing.

Provide justification (i.e. weather conditions).

Provide instruction for reimbursement or date/location of rescheduled

Reimbursement or transfer of insurance to another day can ONLY happen if the race has not been started including warm-ups, practice time, and/or driver testing. If race was started and then shut down due to conditions, then race insurance has been used and any rescheduling for another day would entail purchasing race insurance again. If race was NOT started, then a full reimbursement or transfer of full coverage is possible if Treasurer has email stating condition on or prior to race day. If asking for a refund, please state who check should be made to and where it should be sent. If rescheduling please fill out another race day event form found on website.

Day after the event

Notify the media

Write a short press release describing the event; Send to a specific contact person at the local Newspaper, magazine, TV and radio. Offer to provide photos, video, and complete results.

Week after the event

Notify the teams

Send the press release, complete results, photos, prizes and awards to the teams

Notify Electrathon America

Send the press release, photos and complete results to the EA web site. Send any new membership forms and fees to Electrathon America.

Send thank you notes

Thank the location owners and any sponsors. Include the press release and any tax deductible documentation they may require. Offer to provide photos, video, and complete results. List and describe media coverage.

FORMS

THESE THREE ONLINE FORMS ARE ONLY AVAILABLE AT www.ElectrathonAmerica.org

- Membership Application Form (www.ElectrathonAmerica.org)
- Sanctioned Event Request Form (www.ElectrathonAmerica.org)
- Insurance Request Form (www.ElectrathonAmerica.org)

ALL OTHER EVENT RELATED FORMS are on the following pages of this handbook.

VEHICLE INSPECTION FORM

| | |
|--|--|
| | |
|--|--|

Name (car owner or team leader) _____

School or Team Name (if applicable) _____

Address (This is where awards and race information will be sent) _____

City _____ State _____ ZIP _____

Phone Number _____ E-Mail Address _____

Car Number _____

State _____

Class:

- Standard
- Solar
- Advanced Battery

Division:

- High School
- Open

All classes must meet Electrathon America Rules

- Entry Fees Paid
- Liability Form Signed
- Electrathon America Competitor Membership

VEHICLE INSPECTION CHECK LIST

- Electrathon America vehicle number clearly visible (6+“ high and contrasting color)
- Visual inspection of structural integrity appears good
- Overall car no more that 48” (4') wide at widest point and 12 feet long or less
- Roll bar seems able to support driver's weight--bracing at highest point
- Roll bar protects driver through full range of motion side to side and forward
- If roll bar is not one piece, it is triangulated at all joints
- Driver stays under plane (roll bar to front support) when seat belted in and leans forward
- Tires are pneumatic and tread is in acceptable condition
- Ground clearance will be tested by ability to roll over a 1 1/2” board without touching.
- Bottom pan so that driver cannot make contact with the track and protects driver from ground
- Bodywork or structural protection from head on and side impact & encloses all of the driver's body parts including legs/feet so they can not escape the car's protection.
- Sides high enough that if other cars go over it in a wreck the driver is not hurt
- No exposed sharp edges or components. Nose cone is not overly pointed or sharp, and has at least a 3” radius (6” diameter) in at least one direction (checked with go/no go device).
- Chain and motor area has guard to protect the driver and others
- Good visibility and field of vision- checked with clipboard held in several locations
- Rear view mirror(s) at least 8 square inches-can see clearly on both sides of the vehicle.
- Axle diameter at least 12 mm / 1/2” unless supported on both ends
- Cotter pins or safety wire used to secure cantilevered wheel axle nuts-not just lock or jam nuts
- 5 point seat belt system is as per handbook, securely attached at least 3” below 'body parts', can lift the weight of the vehicle. Holds the driver secure and 'immobile.'
- Brake inspection- Car will not roll when pushed from behind (skids or stationary) and has two wheels on the same axle with brakes.
- Steering inspection- Can make 25 foot turning radius and appears safe and stable at high speeds
- Throttle automatically shuts off when released
- Circuit breaker or fuse between batteries and motor of correct size for wiring gauge and length
- Inside kill Switch driver accessible and the outside kill switch has a 4” red triangle & easy to use
- Wiring appears safe (terminals tight, insulation good, frame not grounded, wires not rubbing, etc.)
- Batteries securely mounted to structural part of car so they cannot come loose in an accident
- If lead acid batteries-- weigh less than 73 pounds and are non-leakable standard acid batteries
- If Advanced Batteries, type is approved in handbook and appropriate weight for type

Battery manufacture _____ Model (or serial) number _____

Battery Type _____ Battery Quantity _____ System Voltage _____

INSPECTION
COMPLETED
(Initialed by Inspector)

INITIAL INSPECTOR'S COMMENTS OR RECOMMENDATIONS: _____

DRIVER INSPECTION FORM

1st EVENT

INSPECTED AT _____ DATE _____ CAR OK _____

DRIVER'S NAME _____ DL # _____

STATE _____

____ Total weight ____ Driver's weight ____ Ballast weight _____ Item used

____ Signed liability release form AND minor form signed by guardian if under 18

____ Can exit car in less than 20 seconds ____ Good visibility ____ Stays under roll bar

____ Full DOT helmet ____ Eye protection ____ Long pants & sleeves ____ Gloves (open car only)

____ Hair does not reach drive train, ____ necklaces, bracelets, large earrings, etc. Removed:

INSPECTOR'S NAME _____ COMMENTS/RECOMMENDATIONS:

2nd EVENT

INSPECTED AT _____ DATE _____ CAR OK _____

DRIVER'S NAME _____ DL # _____

STATE _____

____ Total weight ____ Driver's weight ____ Ballast weight _____ Item used

____ Signed liability release form AND minor form signed by guardian if under 18

____ Can exit car in less than 20 seconds ____ Good visibility ____ Stays under roll bar

____ Full DOT helmet ____ Eye protection ____ Long pants & sleeves ____ Gloves (open car only)

____ Hair does not reach drive train, ____ necklaces, bracelets, large earrings, etc. Removed:

INSPECTOR'S NAME _____ COMMENTS/RECOMMENDATIONS:

3rd EVENT

INSPECTED AT _____ DATE _____ CAR OK _____

DRIVER'S NAME _____ DL # _____

STATE _____

____ Total weight ____ Driver's weight ____ Ballast weight _____ Item used

____ Signed liability release form AND minor form signed by guardian if under 18

____ Can exit car in less than 20 seconds ____ Good visibility ____ Stays under roll bar

____ Full DOT helmet ____ Eye protection ____ Long pants & sleeves ____ Gloves (open car only)

____ Hair does not reach drive train, ____ necklaces, bracelets, large earrings, etc. Removed:

INSPECTOR'S NAME _____ COMMENTS/RECOMMENDATIONS:

DRIVER INSPECTION FORM

4th EVENT

INSPECTED AT _____ DATE _____ CAR OK _____

DRIVER'S NAME _____ DL # _____

STATE _____

____ Total weight ____ Driver's weight ____ Ballast weight _____ Item used

____ Signed liability release form AND minor form signed by guardian if under 18

____ Can exit car in less than 20 seconds ____ Good visibility ____ Stays under roll bar

____ Full DOT helmet ____ Eye protection ____ Long pants & sleeves ____ Gloves (open car only)

____ Hair does not reach drive train, ____ necklaces, bracelets, large earrings, etc. Removed:

INSPECTOR'S NAME _____ COMMENTS/RECOMMENDATIONS:

5th EVENT

INSPECTED AT _____ DATE _____ CAR OK _____

DRIVER'S NAME _____ DL # _____

STATE _____

____ Total weight ____ Driver's weight ____ Ballast weight _____ Item used

____ Signed liability release form AND minor form signed by guardian if under 18

____ Can exit car in less than 20 seconds ____ Good visibility ____ Stays under roll bar

____ Full DOT helmet ____ Eye protection ____ Long pants & sleeves ____ Gloves (open car only)

____ Hair does not reach drive train, ____ necklaces, bracelets, large earrings, etc. Removed:

INSPECTOR'S NAME _____ COMMENTS/RECOMMENDATIONS:

6th EVENT

INSPECTED AT _____ DATE _____ CAR OK _____

DRIVER'S NAME _____ DL # _____

STATE _____

____ Total weight ____ Driver's weight ____ Ballast weight _____ Item used

____ Signed liability release form AND minor form signed by guardian if under 18

____ Can exit car in less than 20 seconds ____ Good visibility ____ Stays under roll bar

____ Full DOT helmet ____ Eye protection ____ Long pants & sleeves ____ Gloves (open car only)

____ Hair does not reach drive train, ____ necklaces, bracelets, large earrings, etc. Removed:

INSPECTOR'S NAME _____ COMMENTS/RECOMMENDATIONS:

OFFICIAL PROTEST FORM

As a competitor in this event I believe that an unfair advantage has been gained by another participant by violating the Electrathon America Design or Event Rules. I thereby file this protest with the Event Steward and request that that the results of the competition be stated as unofficial until the protest has been resolved.

I hereby submit \$25.00 as a protest fee with the Event Steward and request that the issue be investigated. I understand that if my protest is found by the Event Steward to be without justification my protest fee will be forfeited to the Event and may be claimed by the accused party if vehicle disassembly for inspection is required, or if hardship is caused to the accused due to the investigation. Claims to the \$25.00 will be at the sole discretion of the Event Steward.

I understand that if my protest is upheld, my protest fee will be returned to me. The competition results will be changed to reflect the findings of the investigation, and the accused may be disqualified from this event, if the situation warrants.

I understand that the Event Steward's decision will be final in this protest.

Event Name: _____ Location: _____ Date: _____

Event or Design Rule that was Violated: _____

Time Rule was Violated: _____

Reason for the Protest: _____

Name of person filing protest: _____

Signature: _____ Date: _____ Time: _____

Result of investigation: _____

Steward Signature: _____ Date: _____ Time: _____

LAP TALLY SHEET

Individual Lap/Time Method

Car Number

State

TOTAL LAPS
COMPLETED

School or Team Name _____

Driver Name _____

Date _____

Lap counter's name _____

Event Location _____

| LAP | TIME | LAP | TIME | LAP | TIME | LAP | TIME | LAP | TIME |
|-----|--------------------------------|-----|--------------------------------|-----|--------------------------------|-----|--------------------------------|-----|--------------------------------|
| 1 | <input type="checkbox"/> _____ | 31 | <input type="checkbox"/> _____ | 61 | <input type="checkbox"/> _____ | 91 | <input type="checkbox"/> _____ | 121 | <input type="checkbox"/> _____ |
| 2 | <input type="checkbox"/> _____ | 32 | <input type="checkbox"/> _____ | 62 | <input type="checkbox"/> _____ | 92 | <input type="checkbox"/> _____ | 122 | <input type="checkbox"/> _____ |
| 3 | <input type="checkbox"/> _____ | 33 | <input type="checkbox"/> _____ | 63 | <input type="checkbox"/> _____ | 93 | <input type="checkbox"/> _____ | 123 | <input type="checkbox"/> _____ |
| 4 | <input type="checkbox"/> _____ | 34 | <input type="checkbox"/> _____ | 64 | <input type="checkbox"/> _____ | 94 | <input type="checkbox"/> _____ | 124 | <input type="checkbox"/> _____ |
| 5 | <input type="checkbox"/> _____ | 35 | <input type="checkbox"/> _____ | 65 | <input type="checkbox"/> _____ | 95 | <input type="checkbox"/> _____ | 125 | <input type="checkbox"/> _____ |
| 6 | <input type="checkbox"/> _____ | 36 | <input type="checkbox"/> _____ | 66 | <input type="checkbox"/> _____ | 96 | <input type="checkbox"/> _____ | 126 | <input type="checkbox"/> _____ |
| 7 | <input type="checkbox"/> _____ | 37 | <input type="checkbox"/> _____ | 67 | <input type="checkbox"/> _____ | 97 | <input type="checkbox"/> _____ | 127 | <input type="checkbox"/> _____ |
| 8 | <input type="checkbox"/> _____ | 38 | <input type="checkbox"/> _____ | 68 | <input type="checkbox"/> _____ | 98 | <input type="checkbox"/> _____ | 128 | <input type="checkbox"/> _____ |
| 9 | <input type="checkbox"/> _____ | 39 | <input type="checkbox"/> _____ | 69 | <input type="checkbox"/> _____ | 99 | <input type="checkbox"/> _____ | 129 | <input type="checkbox"/> _____ |
| 10 | <input type="checkbox"/> _____ | 40 | <input type="checkbox"/> _____ | 70 | <input type="checkbox"/> _____ | 100 | <input type="checkbox"/> _____ | 130 | <input type="checkbox"/> _____ |
| | | | | | | | | | |
| 11 | <input type="checkbox"/> _____ | 41 | <input type="checkbox"/> _____ | 71 | <input type="checkbox"/> _____ | 101 | <input type="checkbox"/> _____ | 131 | <input type="checkbox"/> _____ |
| 12 | <input type="checkbox"/> _____ | 42 | <input type="checkbox"/> _____ | 72 | <input type="checkbox"/> _____ | 102 | <input type="checkbox"/> _____ | 132 | <input type="checkbox"/> _____ |
| 13 | <input type="checkbox"/> _____ | 43 | <input type="checkbox"/> _____ | 73 | <input type="checkbox"/> _____ | 103 | <input type="checkbox"/> _____ | 133 | <input type="checkbox"/> _____ |
| 14 | <input type="checkbox"/> _____ | 44 | <input type="checkbox"/> _____ | 74 | <input type="checkbox"/> _____ | 104 | <input type="checkbox"/> _____ | 134 | <input type="checkbox"/> _____ |
| 15 | <input type="checkbox"/> _____ | 45 | <input type="checkbox"/> _____ | 75 | <input type="checkbox"/> _____ | 105 | <input type="checkbox"/> _____ | 135 | <input type="checkbox"/> _____ |
| 16 | <input type="checkbox"/> _____ | 46 | <input type="checkbox"/> _____ | 76 | <input type="checkbox"/> _____ | 106 | <input type="checkbox"/> _____ | 136 | <input type="checkbox"/> _____ |
| 17 | <input type="checkbox"/> _____ | 47 | <input type="checkbox"/> _____ | 77 | <input type="checkbox"/> _____ | 107 | <input type="checkbox"/> _____ | 137 | <input type="checkbox"/> _____ |
| 18 | <input type="checkbox"/> _____ | 48 | <input type="checkbox"/> _____ | 78 | <input type="checkbox"/> _____ | 108 | <input type="checkbox"/> _____ | 138 | <input type="checkbox"/> _____ |
| 19 | <input type="checkbox"/> _____ | 49 | <input type="checkbox"/> _____ | 79 | <input type="checkbox"/> _____ | 109 | <input type="checkbox"/> _____ | 139 | <input type="checkbox"/> _____ |
| 20 | <input type="checkbox"/> _____ | 50 | <input type="checkbox"/> _____ | 80 | <input type="checkbox"/> _____ | 110 | <input type="checkbox"/> _____ | 140 | <input type="checkbox"/> _____ |
| | | | | | | | | | |
| 21 | <input type="checkbox"/> _____ | 51 | <input type="checkbox"/> _____ | 81 | <input type="checkbox"/> _____ | 111 | <input type="checkbox"/> _____ | 141 | <input type="checkbox"/> _____ |
| 22 | <input type="checkbox"/> _____ | 52 | <input type="checkbox"/> _____ | 82 | <input type="checkbox"/> _____ | 112 | <input type="checkbox"/> _____ | 142 | <input type="checkbox"/> _____ |
| 23 | <input type="checkbox"/> _____ | 53 | <input type="checkbox"/> _____ | 83 | <input type="checkbox"/> _____ | 113 | <input type="checkbox"/> _____ | 143 | <input type="checkbox"/> _____ |
| 24 | <input type="checkbox"/> _____ | 54 | <input type="checkbox"/> _____ | 84 | <input type="checkbox"/> _____ | 114 | <input type="checkbox"/> _____ | 144 | <input type="checkbox"/> _____ |
| 25 | <input type="checkbox"/> _____ | 55 | <input type="checkbox"/> _____ | 85 | <input type="checkbox"/> _____ | 115 | <input type="checkbox"/> _____ | 145 | <input type="checkbox"/> _____ |
| 26 | <input type="checkbox"/> _____ | 56 | <input type="checkbox"/> _____ | 86 | <input type="checkbox"/> _____ | 116 | <input type="checkbox"/> _____ | 146 | <input type="checkbox"/> _____ |
| 27 | <input type="checkbox"/> _____ | 57 | <input type="checkbox"/> _____ | 87 | <input type="checkbox"/> _____ | 117 | <input type="checkbox"/> _____ | 147 | <input type="checkbox"/> _____ |
| 28 | <input type="checkbox"/> _____ | 58 | <input type="checkbox"/> _____ | 88 | <input type="checkbox"/> _____ | 118 | <input type="checkbox"/> _____ | 148 | <input type="checkbox"/> _____ |
| 29 | <input type="checkbox"/> _____ | 59 | <input type="checkbox"/> _____ | 89 | <input type="checkbox"/> _____ | 119 | <input type="checkbox"/> _____ | 149 | <input type="checkbox"/> _____ |
| 30 | <input type="checkbox"/> _____ | 60 | <input type="checkbox"/> _____ | 90 | <input type="checkbox"/> _____ | 120 | <input type="checkbox"/> _____ | 150 | <input type="checkbox"/> _____ |

LAP TALLY SHEET Multiple Car Lap Method

Date _____

Indicate order cars cross the finish line under checkered flag (1,2,3,4,5,6)

| | | | | | |
|--------------------------|--------------------------|--------------------------|--------------------------|--------------------------|--------------------------|
| <input type="checkbox"/> | <input type="checkbox"/> | <input type="checkbox"/> | <input type="checkbox"/> | <input type="checkbox"/> | <input type="checkbox"/> |
| LAP 5 | LAP 5 | LAP 5 | LAP 5 | LAP 5 | LAP 5 |
| CAR NUMBER | CAR NUMBER | CAR NUMBER | CAR NUMBER | CAR NUMBER | CAR NUMBER |

Event Location _____

| | | |
|----------------------|----------------------|----------------------|
| TOTAL LAPS COMPLETED | | <input type="text"/> |
| School or Team Name | <input type="text"/> | <input type="text"/> |
| Driver Name | Car Number | State |

| | | |
|----------------------|----------------------|----------------------|
| TOTAL LAPS COMPLETED | | <input type="text"/> |
| School or Team Name | <input type="text"/> | <input type="text"/> |
| Driver Name | Car Number | State |

| | | |
|----------------------|----------------------|----------------------|
| TOTAL LAPS COMPLETED | | <input type="text"/> |
| School or Team Name | <input type="text"/> | <input type="text"/> |
| Driver Name | Car Number | State |

| | | |
|----------------------|----------------------|----------------------|
| TOTAL LAPS COMPLETED | | <input type="text"/> |
| School or Team Name | <input type="text"/> | <input type="text"/> |
| Driver Name | Car Number | State |

| | | |
|----------------------|----------------------|----------------------|
| TOTAL LAPS COMPLETED | | <input type="text"/> |
| School or Team Name | <input type="text"/> | <input type="text"/> |
| Driver Name | Car Number | State |

| | | |
|----------------------|----------------------|----------------------|
| TOTAL LAPS COMPLETED | | <input type="text"/> |
| School or Team Name | <input type="text"/> | <input type="text"/> |
| Driver Name | Car Number | State |

Lap counter's name _____

Spotter's name _____

REVISION HISTORY

| Version | Date of Issue | Author(s) | Change(s) |
|---------|---------------|-----------|--|
| A-F | 09/27/2017 | ML | Prior history as released. |
| G | 09/28/2017 | KS | Added this revision history table; Updated rules as per May 2017 Board of Directors meeting vote; corrected formatting and in some cases word clarifications that did not change meaning; updated cover and other images. |
| H | 3/7/2020 | KS | As per 1/30/2020 EA board decisions: Updated cover date & revision; Edited pg11 section 24 regarding DRIVER age; Removed 2018-19 throughout; Corrected various punctuation & grammar throughout; Removed placed duplicated forms with reference to master on-line forms; Moved all forms to end of Handbook; Renumbered some pages respectively; Removed 2018-19 from several sections. Be aware that a 2/03/2020 DRAFT of this was circulated to board members prior to the released version. |
| J | 3/10/2020 | KS | Removed unnecessary page 47 "Liability release" form and page 51 "Notes"; Updated related subsequent page numbers and table of contents. |
| K | 4/8/2021 | KS | Updated cover only from "2020" to "2021", to ease any concerns that the Handbooks us up to date. No other changes to the previous content was made at this time. |

CALCULATIONS

One US gallon of gasoline contains, on average, the equivalent of about 36.6 kilowatt hours of electricity*.

Actual power consumption data was not available for all the listed runs, so an average of .960 kilowatt hours was assumed. (Drawing 40 amps for one hour at 24 volts is a considered a very good performance for Electrathon.)

That means the energy consumption for the hour would be the equivalent of .0262 US gallons of gasoline:

$$.960 \text{ kwh} / 36.6 \text{ kwh/gallon} = .0262 \text{ gallons}$$

If the distance covered is 62.1 miles, that works out to 2370.22 miles per gallon:

$$62.1 \text{ miles} / .0262 \text{ gallons} = 2370.22 \text{ mpg}$$

This can also be expressed as watt/hours per mile:

$$960 \text{ wh} / 62.1 \text{ miles} = 15.45 \text{ wh/mile}$$

The average cost of U.S. electricity is 10.4 cents per kilowatt/hour**, so an Electrathon vehicle would consume less than 10 cents worth in a race.

$$\$0.104/\text{kwh} \times .960\text{kwh} = \$0.0998$$

These numbers do not reflect the losses incurred when charging the batteries, only the energy consumed during a race.

It should also be noted that the performance numbers of the Electrathon vehicles on the back cover were not all recorded at the same time on the same track, so the list is not intended as a direct comparison. Obviously, size does matter. Corners and hills require more energy. The highest numbers, for example, were achieved on a level 5 mile oval, where lateral resistance was virtually non existent. The list, therefore, is simply a record of the best runs made by each of these vehicles, and is offered as just one example of the many accomplishments made by the program over the years... a sort of 'state of the art' in the world of Electrathon.

The numbers reveal a rather remarkable characteristic of our competition, though... the faster we go, the more 'miles per gallon' we get, or, more appropriately, the higher our level of efficiency, the faster we go.

* Appendix B, Transportation Energy Data Book from the Center for Transportation Analysis of the Oak Ridge National Laboratory

** U.S. Government Energy Information Administration

FOR COMPARISON

| POWER | watts | horsepower |
|--------------------------------|-----------|------------|
| Electrathon Vehicle | 960 | 1.28 |
| human power (hour record). | 275 | 0.37 |
| EcoMarathon. | 400 | 0.53 |
| solar race car (solar panels). | 1500 | 2.00 |
| hair dryer..... | 1200-1875 | 1.60-2.50 |
| Tesla..... | 215,000 | 287 |
| NASCAR Sprint Cup..... | 600,000 | 800 |

| EFFICIENCY | wh/mile | mpg |
|--------------------------------------|---------|------|
| Electrathon vehicle..... | 15.45 | 2370 |
| Shell EcoMarathon (15mph avg). | 4.1 | 8913 |
| human power (hour record 56 miles) | 4.9 | 7469 |
| solar car (64mph avg for 3000 miles) | 25 | 1464 |
| Tesla. | 177 | 206 |
| NASCAR Sprint Cup..... | 7320 | 5 |



Miles
in 1 hour:

ELECTRATHON

MPG*
equivalent:

62.1



Team Electrolite Portland, ME

Ford Michigan Proving Ground 20 JULY 2009

2370

60.9



Cloud Electric Racing Woodenville, WA

Ford Michigan Proving Ground 20 JULY 2009

2324

56.9



Team Pak-Lite Grant's Pass, OR

Ford Michigan Proving Ground 20 JULY 2009

2171

51.0

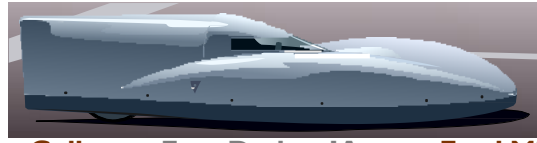

Iowa Central Community College Fort Dodge, IA

Ford Michigan Proving Ground 20 JULY 2009

1947

50.5



Cloud Electric Racing Woodenville, WA

Kansas Speedway 6 OCTOBER 2008

1927

50.2



Cloud Electric Racing Woodenville, WA

New Hampshire Internat'l Speedway 31 OCTOBER 2006

1916

50.2



Mt. Blue High School Farmington, ME

New Hampshire Internat'l Speedway 31 OCTOBER 2006

1916

49.2

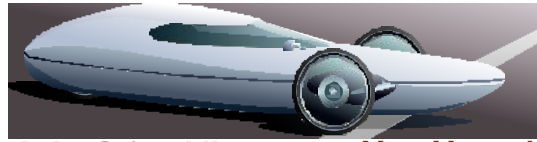

Lake Orion High School Lake Orion, MI

New Hampshire Internat'l Speedway 14 MAY 2000

1878

47.7



Team Electrolite Portland, ME

New Hampshire Internat'l Speedway 9 MAY 1999

1820

47.1



Iowa Central Community College Fort Dodge, IA

New Hampshire Int'l Speedway 31 OCTOBER 2006

1798